

SECTION SIX

Spare parts for: Scalders

Opening Machines

Eviscerators

Maestro Machine

Panconveyor

Final Control Machines

Inside/Outside birdwashers

Heart- and Lung Separators

Neckbreaker/Neckskinslitters

Drop-off Stations

Filetting Machines

Automatic Rehangers

Cut-up Machines

Thigh Deboners

Giblet Pumps

Containersystem GP compatible with Stork



Rodon Int. nr:	Description:	Partnr.OEM:	Pos.nr:
CS.20.001	Closing plate PUR	4M.607.302	5
CS.20.003	Bracket	690.337	15
CS.20.004	Bracket	3M.607.232	13
CS.20.005	Block	4M. 607 . 386	16
VE.DR.031	Compression spring	09.1401.112	27

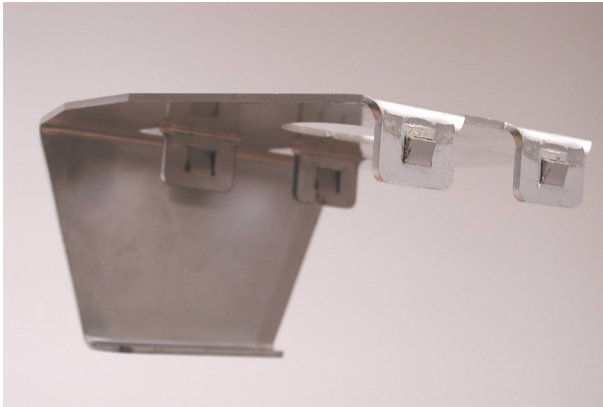

CS.20.003 / CS.20.004

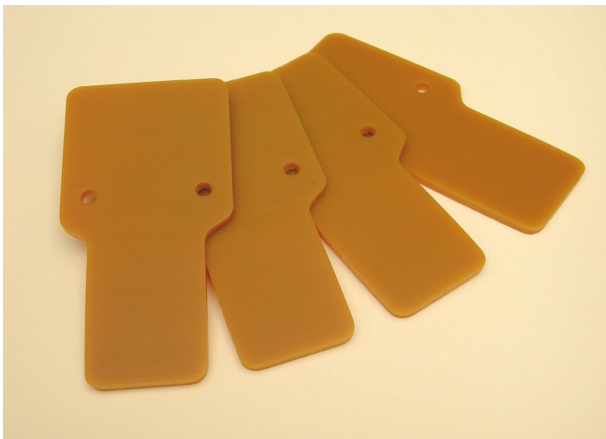
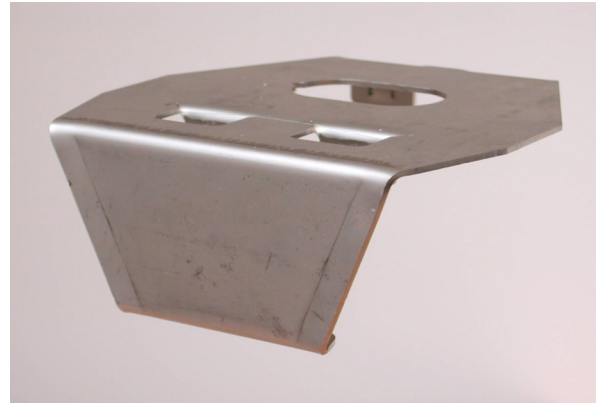

CS.20.001



CS.20.005



VE.DR.031

Containersystem GP compatible with Stork



Rodon Int. nr:	Description:	Partnr.OEM:	Pos. nr:
CS.20.008	Bush Synth. short	645.162	12
CS.20.009	Bush Synth. long	635.857	14
CS.20.010	Side panel long / inside	645.201B	11
CS.20.012	Floorpanel / roofpanel	391.9494 - 645.205	7/20
CS.20.013	Side panel long	602.277	10
CS.20.014	Side panel short	690.513	35
CS.20.015	Floorpanel incl. sidepanel / drawer 5L H=205mm	396.9229 - 397.2420	8/19
CS.20.016	Sliding roof panel	391.6518 - 645.206	20/21
CS.20.020	Floorpanel incl. sidepanel / drawer 4L H=230mm	396.9227—397.0747	8/19

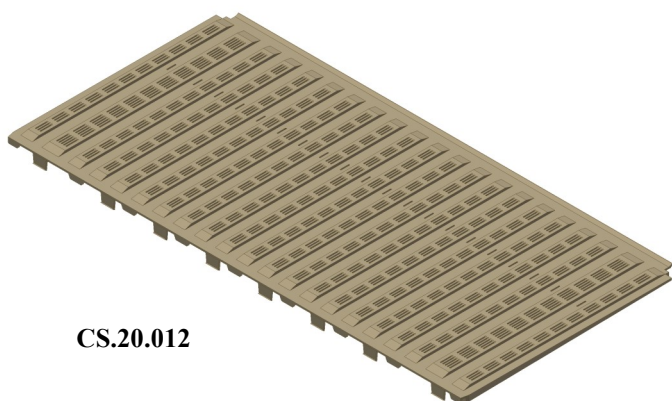

CS.20.012

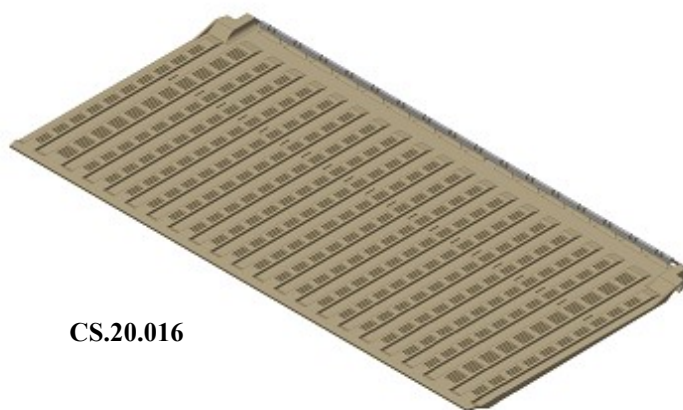

CS.20.016



CS.20.014

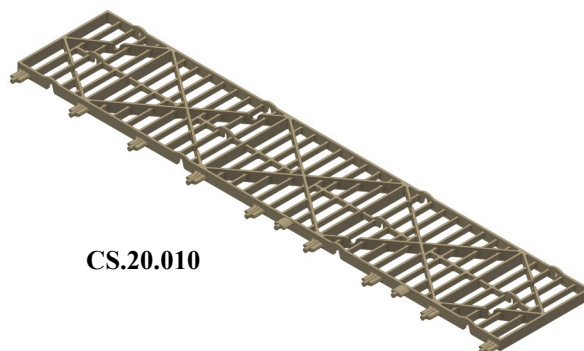

CS.20.010

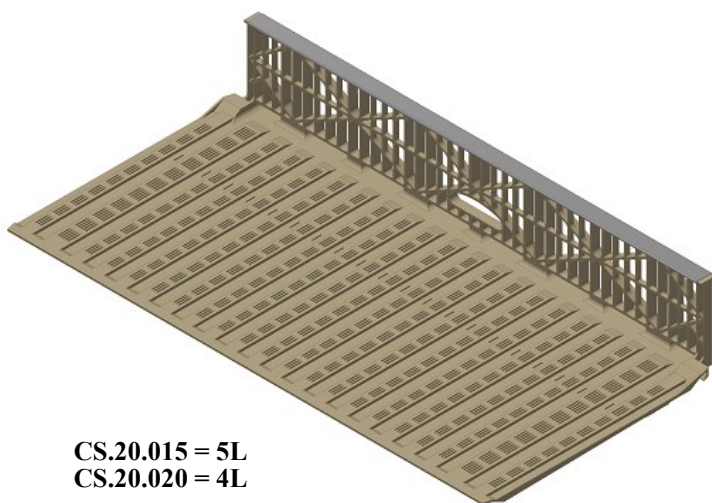

CS.20.015 = 5L
CS.20.020 = 4L

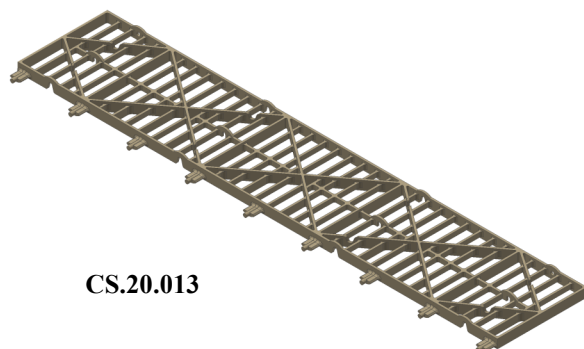

CS.20.013

Containersystem GP compatible with Stork



Rodon Int. nr:	Description:	Partnr.OEM:	Pos.nr:
CS.20.501	Single container 4 layers		
CS.20.502	Single container 5 layers		
CS.20.503	Double container 4 layers		
CS.20.504	Double container 5 layers		



Fully interchangeable with existing GP systems
In galvanised or stainless steel version
Filling system with lifting levels



Scalder Blower

Rodon Int. nr:	Description:	Partnr.OEM:	Pos.nr:
BR.10.012	Blower complete SKG-334-2	89.3304.904.0001	
BR.20.003	Blower complete SKP:49033-01 5,5kW		



Scalder compatible with Meyn Various parts



Rodon Int. nr:	Description:	Partnr.OEM:	Pos.nr:
BR.10.001	Motor support S.S. special coating	0025.0000.009.00	
BR.10.002	Flexible hose S.S. 1¼" L=700	89.2464.904.0069	
BR.10.003	Motor SKG 100 LD4 (ZKF100LD4) 3kW	89.3201.904.0046	
BR.10.004	Reducer for hose 1" – 1¼"		
BR.10.005	Impellor 3 fan S.S.	0990.BR21.001.00	
BR.10.006	Extended shaft with coupling half		
BR.10.007	Coupling half with keyway		
BR.10.008	Intermediate part S.S.		
BR.10.009	Temperature feeler PT100	89.4270.900.0008	
BR.10.010	Digital temperature controller Dtron D304	89.4443.904.0053	
BR.10.011	Blower motor SKG-334-2	89.3304.904.0001	
BR.10.013	Heat exchanger S.S. 1980x730x1,5mm 1 1/2"	89.2490.	
BR.10.014	Pneumatic steam valve	89.2507.070.0007	
BR.10.015	Heat exchanger S.S. 2480x600x1,5mm 1"	89.2490.012.0001	
BR.10.016	Blower complete SAP 380 3kW	0990.BR07.000.83	
BR.10.017	Hose flex. D=110 inside L=6 mtr	89.2464.167.0014	
BR.10.018	Blower complete SAP 380 3kW	48 613 1400	
BR.10.019	Propellorshaft D=30mm L=500mm	0025.0000.013.00	
BR.10.020	Magnetic Valve 1 1/4"	89.2522.040.0009	
BR.10.021	Magnetic Valve 1 1/4"		
BR.10.022	Blower 2BH1630-7AH26-Z 3kW		



BR.10.002



BR.10.004



BR.10.014



BR.10.021



BR.10.009



BR.10.010



BR.10.015

Scalder compatible with Stork



Rodon Int. nr:	Description:	Partnr.OEM:	Pos.nr:
BR.20.001	Synth. disc 78x6,4	09.2001.151	(Rodon pos.1)
BR.20.002	Air diffuser 3/4"	4R.571.417	(2)
BR.20.002A	Air diffuser 3/4" w/ith out ball		
BR.20.003A	Blower complete 2BH18307AH07		
BR.20.004	Blower complete Type 180 - 1,5kW		
BR.20.005	Motor control valve 3-way 1½"		
BR.20.006	Motor control valve 3-way 1"	262.0023 / 00262.4024	(3)
BR.20.007	Motor control valve 3-way 1 1/4"	480.3103	
BR.20.008	Temperature feeler PT100	4M.624.845 / 4R.532.703	
BR.20.009	Temperature feeler PT100 special	4M.624.845	
BR.20.010	Float level switch	521.679	



BR.20.001



BR.20.008



BR.20.002



BR.20.005

Scalder compatible with Linco



Rodon Int. nr:	Description:	Partnr.OEM:	Pos.nr:
BR.40.001	Cut-off valve	990.215.S	
BR.40.002	Shaft	61.035.3331	
BR.40.003	Shaft	61.035.5500	
BR.40.004	Temperature feeler TC-2	E29.0020.002	
BR.40.005	Airblower 330cbm/H 3 kW	48.653.3000 486533000	
BR.40.006	Seat Valve 1 1/2" M/SST House Linco Scalder	70.920.5110.02 / 70.920.7110	
BR.40.007	Solenoid valve, synthetic	70.920.5011	



BR.40.001

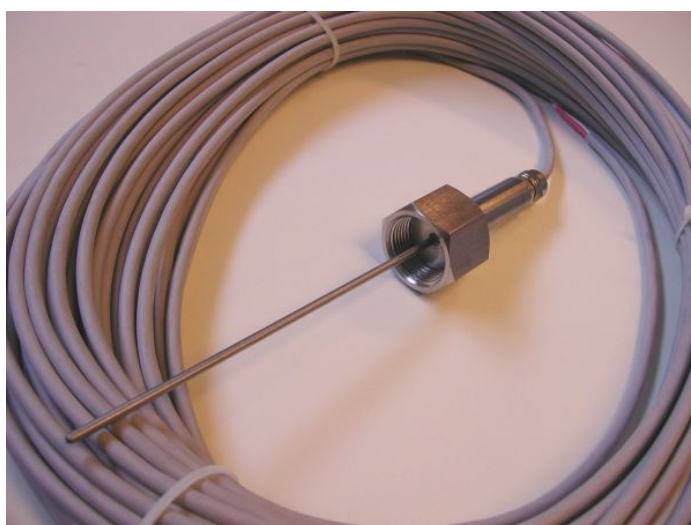

BR.40.004

Miscellaneous Machines



Rodon Int. nr:	Description:	Partnr.OEM:	Pos.nr:
PK.00.001	Jack with spindle	02.25.000.000	
PK.00.002	Bar height adjustment L=720mm		
PK.00.003	Bar height adjustment L=1140mm		
PK.00.004	Bar height adjustment L=1370mm		
PK.00.501	Jack with spindle complete L=900mm 250kg	52.301.1501	
PK.00.502	Jack with spindle complete L=1205/1000mm 500kg		
PK.00.503	Jack with spindle complete L=900mm 500kg		
PL.60.008	Plate		
PL.60.007	Jack		

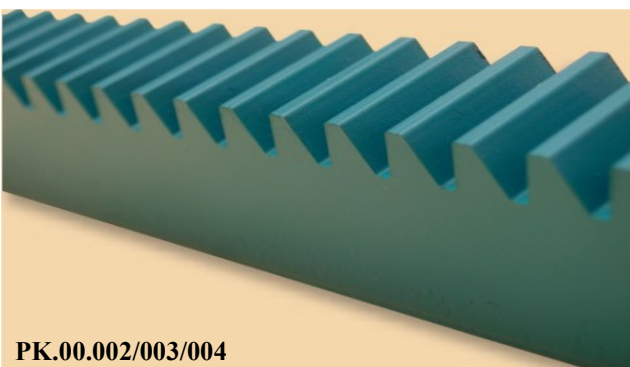
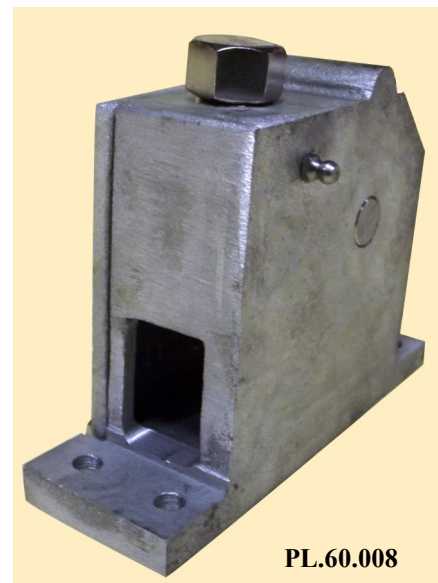
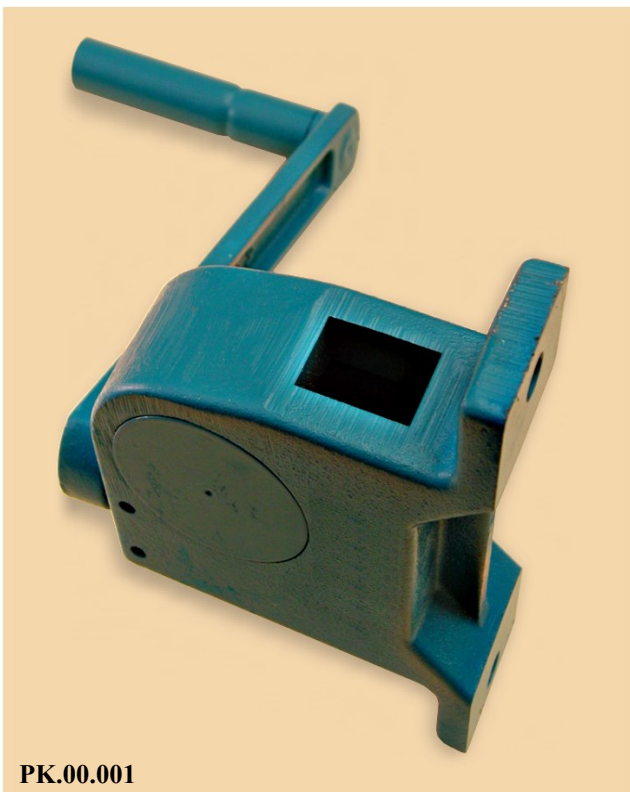

Miscellaneous Machines compatible with Meyn Various Parts



Rodon Int. nr:	Description:	Partnr.OEM:	Pos.nr:
PK.10.001	Rubber sleeve V6—400	89.3531.160.0005 – 99.10789	67/77
PK.10.002	Protecting cover synth.	0990.W001.004.00 – 990.1408	2
PK.10.003	Brass collar bushing for carrier pin	0990.W001.007.00 – 99.0610	4/6/18/23
PK.10.004	Starknob M12	89.1503.900.0003	
PK.10.005	Collar sleeve for carrierpin	0990.W001.008.00	
PK.10.006	Crank handle	0990.HV02.000.02	
PK.10.007	Showerhead 1/2" incl. kogelgewricht	89.2493.900.0003	
PK.10.008	Crank only S.S.	0990.HV02.000.02	
PK.10.009	Cover for PCJ45 bearing	0990.A708.002.00	
PK.10.010	Protecting cover synth.	0990.W001.005.00	
PK.10.011	Bearing bush Bronze	0990.W001.015.00	
PK.10.012	Bush S.S. 20x4,5 L=43	0990.AB10.343.00	
PK.10.013	Bearingbush, Bronze 24x20,1	0990.A202.099.00	

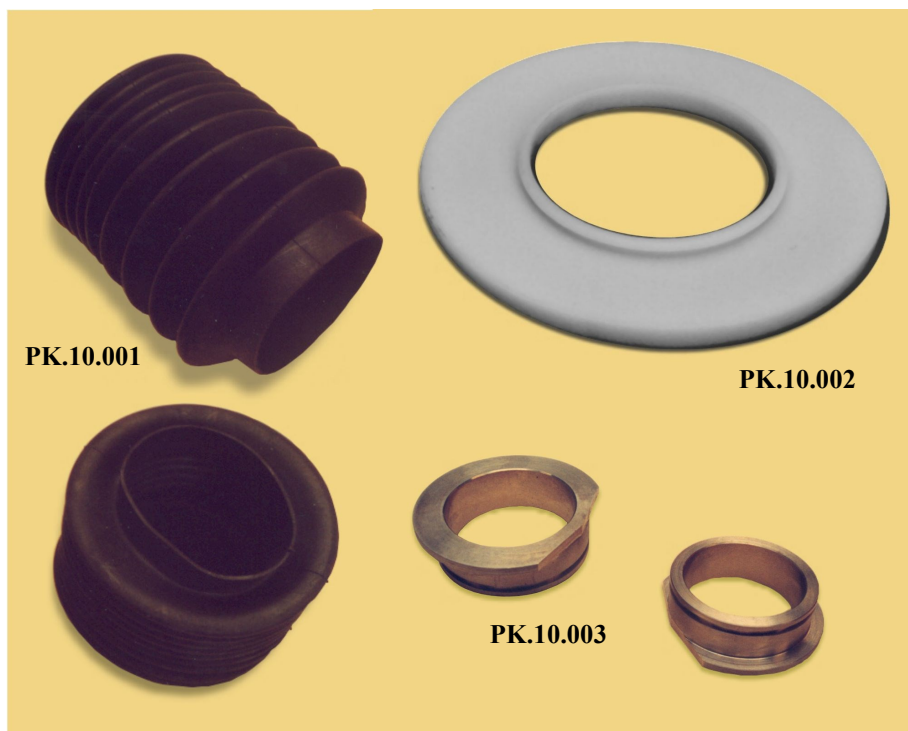

Head and Windpipepuller compatible with Meyn Starwheel



Rodon Int. nr:	Description:	Partnr.OEM:	Pos.nr:
HP.10.001	Starwheel D=39mm	0199.0000.032.00 / 199.00.032	55



Opening Machine compatible with Meyn Opener Arm Complete



Rodon Int. nr:	Description:	Partnr.OEM:	Pos.nr:
OP.10.002	Roller	0990.AB00.011.00	96
OP.10.505	Arm complete	0990.BL01.000.01	35



OP.10.505



OP.10.002



Opener compatible with Meyn Universal opener



Rodon Int. nr:	Description:	Partnr.OEM:	Pos.nr:
OP.10.509	Universal opener unit	0990.BL01.000.24	
OP.10.001	Slide block	0990.BL00.001.00	1
NC.10.013	Spacer	0990.A200.001.00	2
1002.0000.SS13	Ball bearing SS	89.0691.017.0006	3
1001.7991.1030	Countersunk headscrew S.S.	89.1126.015.0008	4
LB.KU.002	Bearing bushing L=60 synth.	0990.A202.011.00	5
LBK15/19x25	Collar bearingbushing	89.0655.045.0004	6
VE.TO.010	Torsionspring opener	0990.V002.015.00	7
OP.10.004	Shaftbolt	0990.PK13.001.00	8
OP.10.507	Arm suitable for pivotable knifeholder	0990.BL01.000.25	9
OP.10.503	Opener arm complete universal type	0990.BL01.000.21	10
1001.0933.1020	Tap bolt S.S.		11
OP.10.506	Knifeholder, pivotable	0990.BL01.000.22	12
1001.0933.0835	Tap bolt S.S.	89.0804.015.0004	13
1001.0985.0008	Locknut SS	89.0914.015.0001	14
OP.10.002	Roller	0990.AB00.007.00	15
OP.10.005	Ring S.S.	0990.A703.002.00	16
1005.0094.3225	Splitpin	89.0936.010.0003	17
VM.092	Opener & backstrip cutter blade Meyn type II	89.5080.207.0007	18
OP.10.007	Lock plate	0990.BL01.000.20	19
1001.0084.0408	Cyl.headscrew S.S.	89.1003.015.009	20

Opener compatible with Meyn
Universal opener

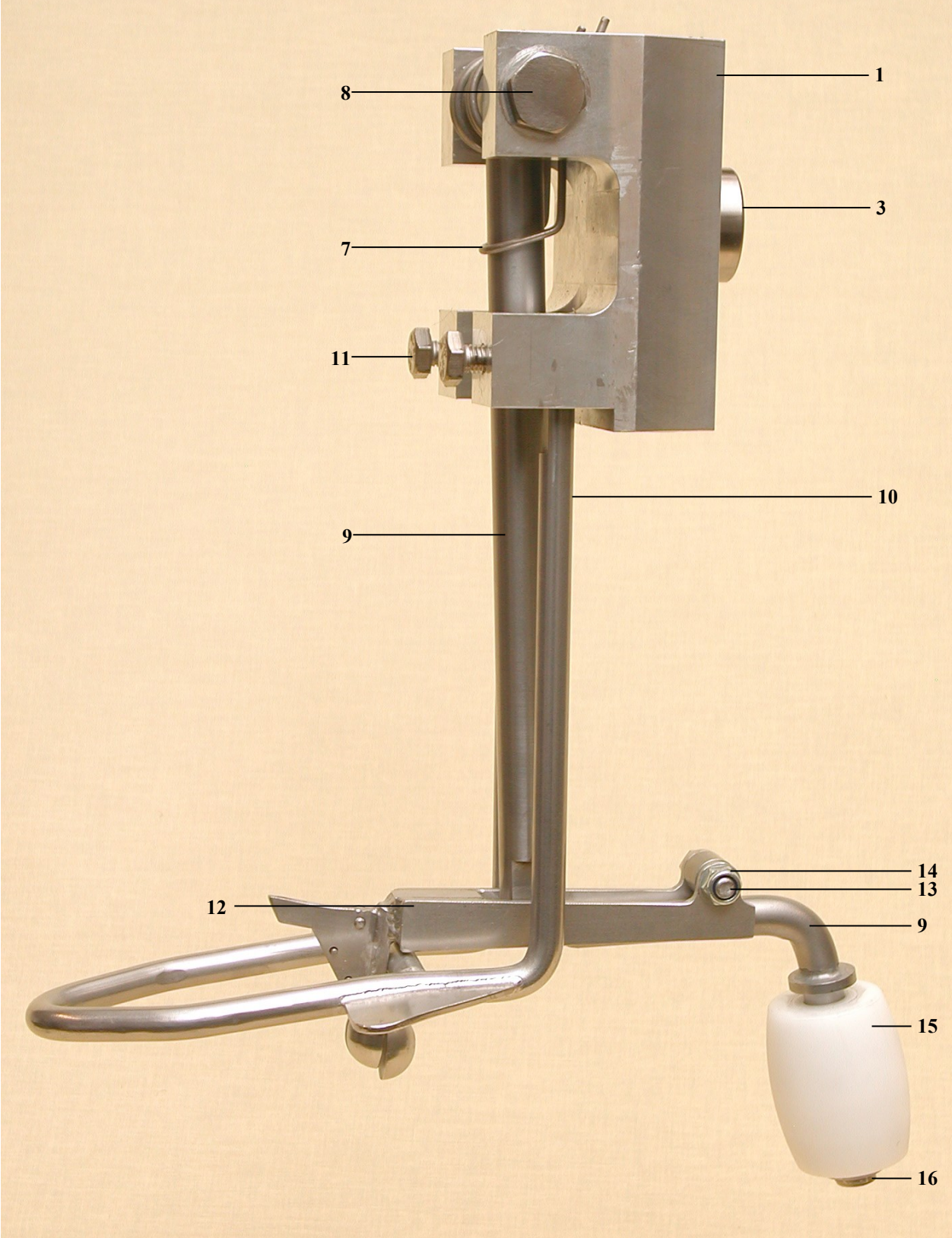

Opening Machine compatible with Meyn Reconditioned Parts



Rodon Int. nr:	Description:	Partnr.OEM:	Pos.nr:
OP.RE.504	Complete unit reconditioned RH	0990.BL01.000.19– 061.00.150	100
OP.RE.508	Complete unit reconditioned LH	0990.BL01.000.05– 061.00.150	100
OP.10.002	Roll	0990. AB00.011.00–061.44.192	99
OP.10.004	Shaft Bolt	0990.PK13.001.00 – 990.0070	31
VE.TO.010	Torsion Spring	0990.V002.015.00 – 061.00.191	34
NC.10.013	Spacer	0990.A200.001.00 – 990.0564	37

Available in new and reconditioned version

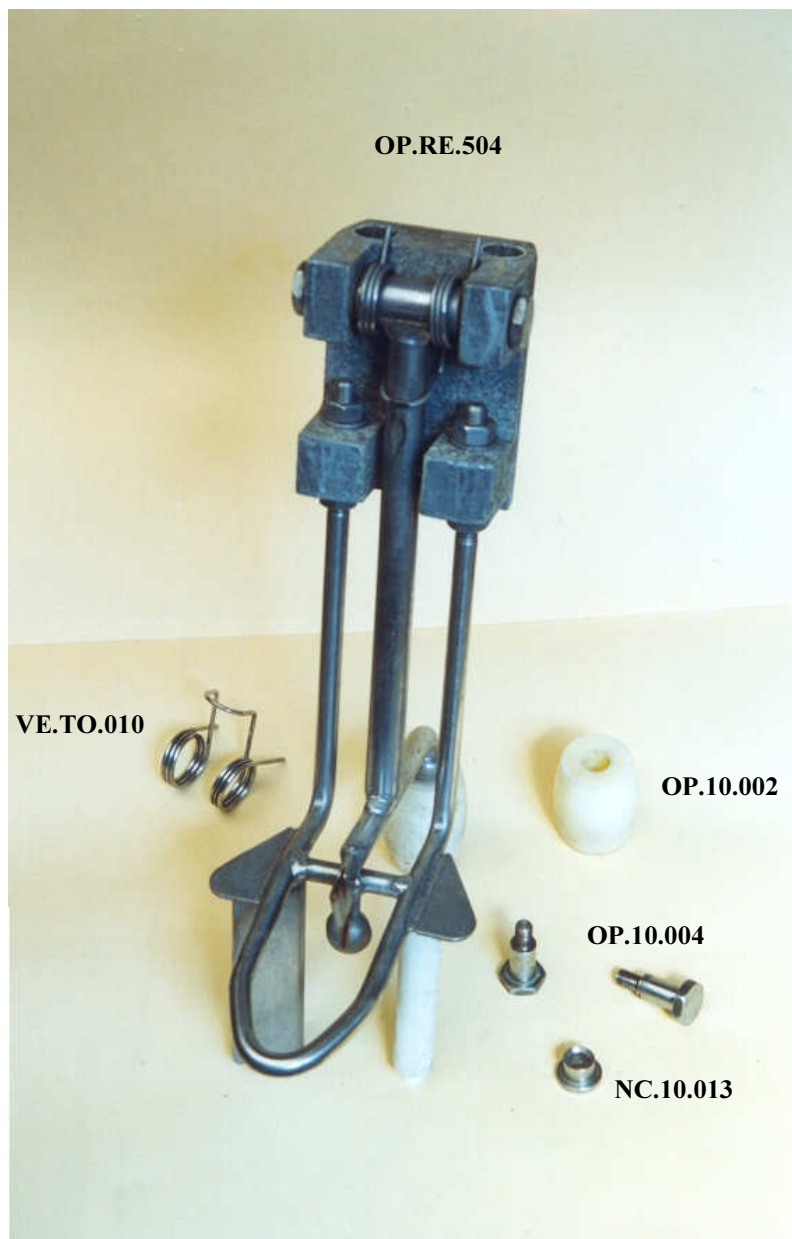

Eviscerating Machine Apollo compatible with Meyn

Various parts / slide blocks



Rodon Int. nr:	Description:	Partnr.OEM:	Pos.nr:
EV.10.004	Cam follow roller	0990.AB00.009.00 –164.04.031	33
EV.10.006	Shaft	0990.A014.001.00 –164.04.032	32
EV.10.011	Shaft	0164.0004.030.00 – 164.04.030	40
EV.10.008	Plunger rod	0990.PK26.001.07– 164.04.019	39
EV.10.501	Coupling piece	0990.PK26.000.24– 164.04.115	46
EV.10.009	Upper slide block	0990.BL00.009.00-164.04.049	
EV.10.010	Lower slide block	0990.BL00.008.00-164.04.048	



EV.10.011

EV.10.006



EV.10.004



EV.10.008



EV.10.501



EV.10.009

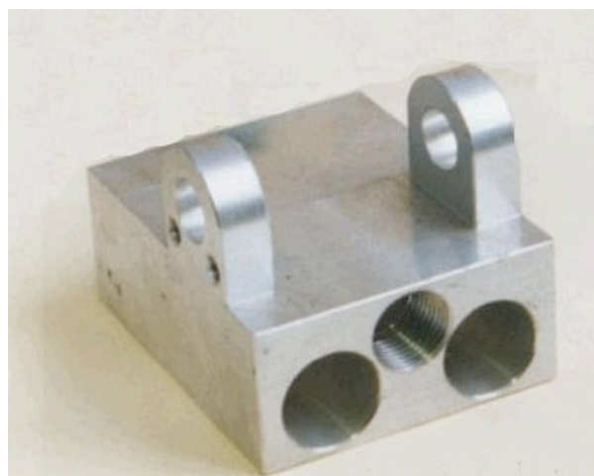

EV.10.010

Eviscerating Machine Apollo compatible with Meyn Reconditioned Parts



Rodon Int. nr:	Description:	Partnr.OEM:	Pos.nr:
EV.RE.506	Eviscerating unit reconditioned	0990.PK26.000.09-164-04-210	186
EV.RE.507	Centring unit reconditioned	0990.PK26.000.05-164-04-214	187

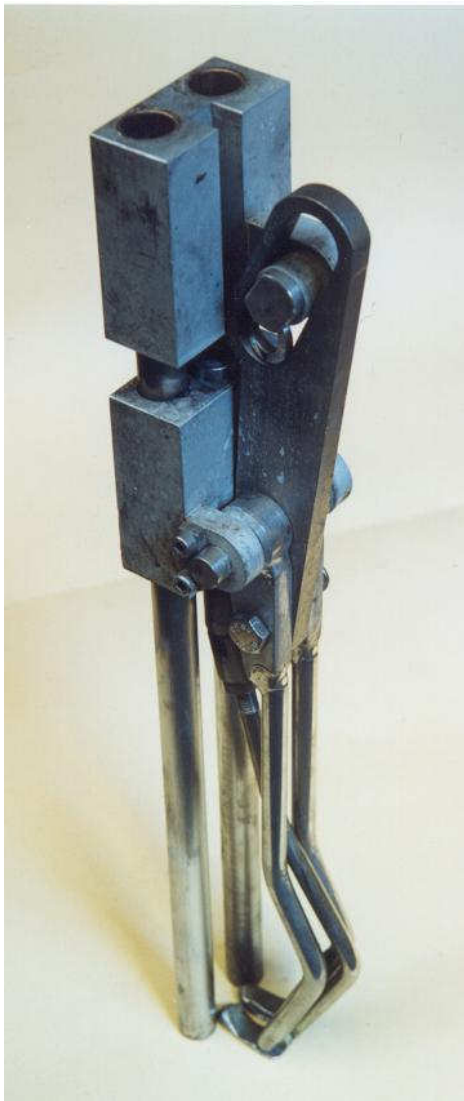

EV.RE.506



EV.RE.507

Eviscerating Machine Apollo compatible with Meyn Complete unit



Rodon Int. nr:	Description:	Partnr.OEM:	Pos.nr:
EV.10.506	Eviscerating unit	0990.PK26.000.09	186
SA.10.012	Intermediate shaft L=479	0990.A005.001.00	30
LBC20/24x25	Bearing bushing 20x24 L=25	89.0646.045.0001	31
EV.10.006	Shaft	0990.A014.001.00	32
EV.10.004	Cam follow roller	0990.AB00.009.00	33
EV.10.007	Connection rod	0990.PK26.002.36	34
NC.10.013	Spacer	0990.A200.001.00 - 990.0564	35
1002.0000.SS13	Ball bearing	89.0691.017.0006 - 99.22848	36
1001.7991.1030	Countersunk headscrew	89.1126.015.0004 - 99.11563	37
1001.0985.0010	Locknut	89.0914.015.0002	38
EV.10.008	Plunger rod	0990.PK26.001.07	39
EV.10.011	Shaft	0164.0004.030.00	40
EV.10.???		0164.0004.034.00 - 164.04.034	41
1001.0912.0612		89.1104.015.0005	42
VE.DR.007	Compression Spring	0990.V006.026.00	43
		0990.PK26.003.07 - 164.04.033	44
		89.0901.015.007	45
EV.10.501	Coupling	0990.PK26.000.24	46
LBK15/19x25	Collar bearingbushing	89.0655.045.0004	48
EV.RE.502	Eviscerating rod unit, reconditioned		49
1001.0933.1045	Tap Bolt	89.0805.015.0010	50
	Eviscerating rod unit, reconditioned		51
EV.10.009	Upper slide block		52
EV.10.010	Slide block		53

Meyn Eviscerating Machine Apollo Complete unit

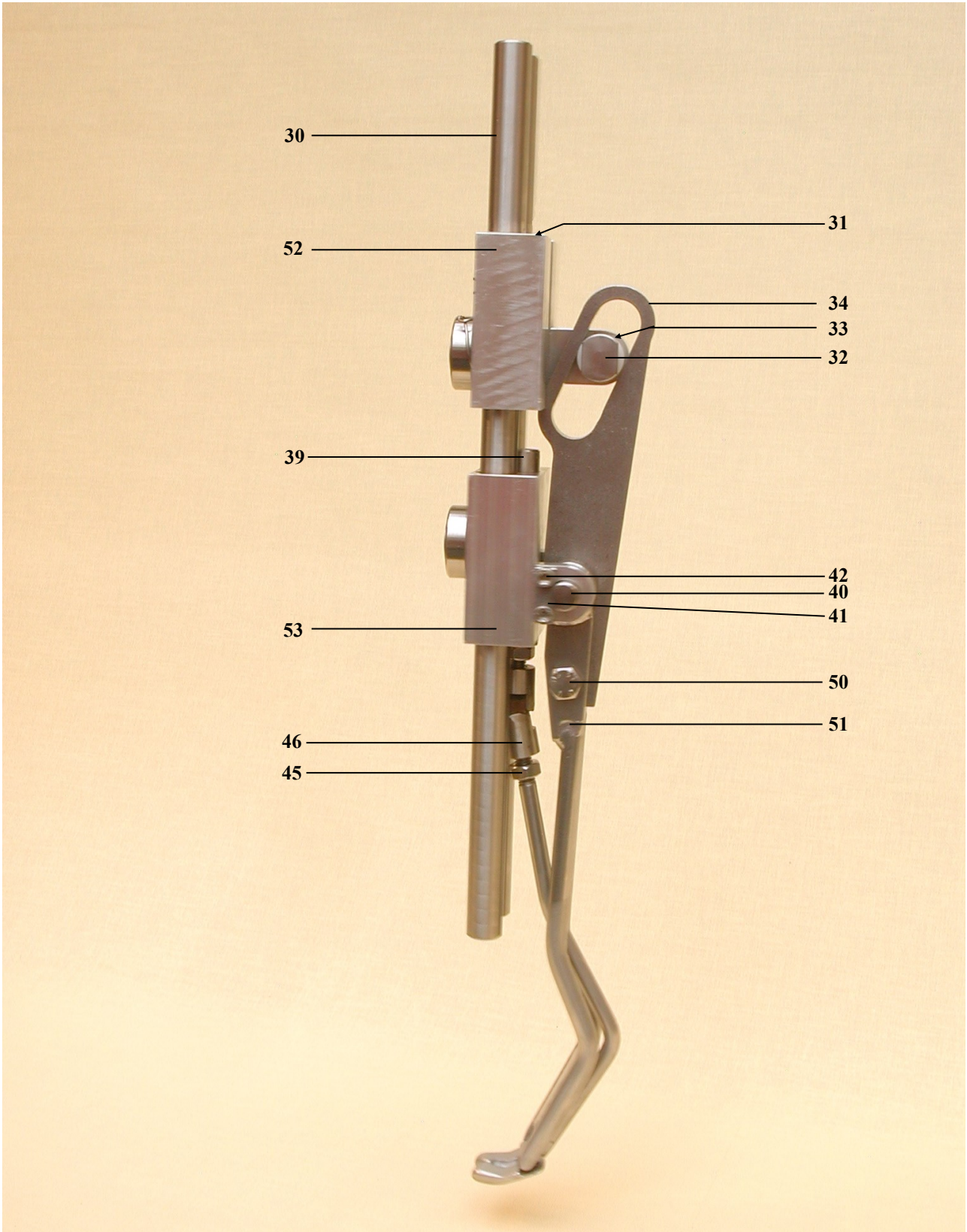

Eviscerating machine compatible with Meyn Centring unit



Rodon Int. nr:	Description:	Partnr.OEM:	Pos.nr:
EV.10.507	Centring unit	0990.PK26.000.05 - 164-04-214	187
EV.10.005	Roller	0990.AB00.006.00	47
EV.10.013	Shaft	0990.A202.020.00 - 164.04.047	60
EV.10.003	Roller	0990.AB00.005.00 - 990.4436 164.04.042	65
EV.10.003A	Roller	0990.AB00.005.00 - 990.4436 164.04.042	70
1005.0094.0320	Splitpin	99.11050 - 89.0936.010.0003	66

Eviscerating machine compatible with Meyn Centring unit

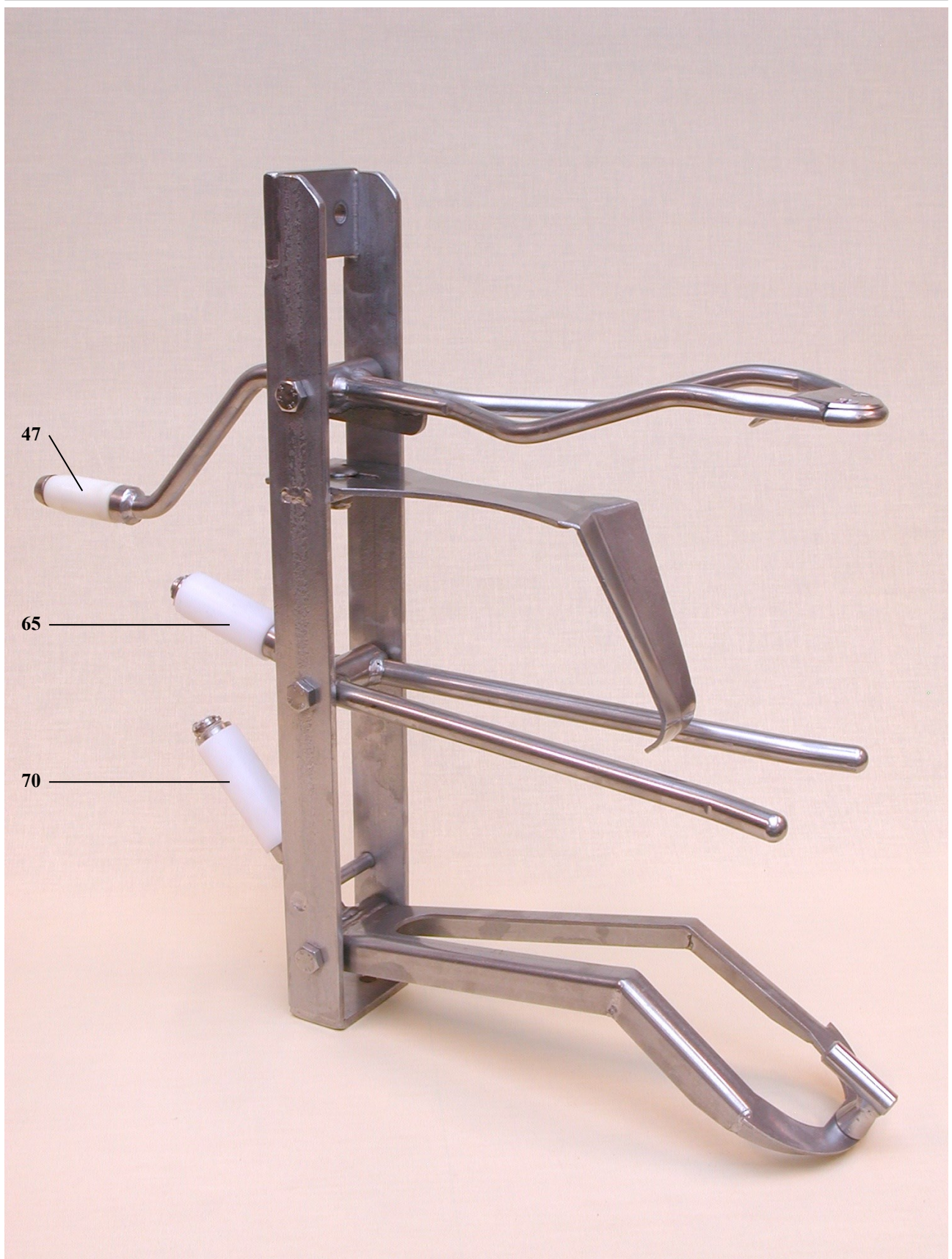

Eviscerating Machine Maestro compatible with Meyn

Various parts



Rodon Int. nr:	Description:	Partnr.OEM:	Pos.nr:
MA.10.006	Upperblock Synth.	0586.0068.004.32	01
MA.10.010	Valve	0586.0068.002.32	02
MA.10.012	Shaft S.S.L=116 D15	0586.0000.003.32	
MA.10.013	Lower block, synthetic	0586.0068.A00.33	
MA.10.017	Back support roller external ring	0586.0032.005.29	
MA.10.018	Sliding block	0586.0068.005.32	01
MA.10.027	Fork block	0586.0068.D01.05	
MA.10.030	Valve new type	0586.0032.X05.99	
MA.10.503	Lower pack unit complete	0586.0068.A00.20	
MA.10.503A	Lower pack unit complete (new type)	0586.0068.C00.20	
MA.10.504	Eviscerating spoon (small bird)	0586.0068.000.94	



Eviscerating Machine Maestro compatible with Meyn

Various parts



Rodon Int. nr:	Description:	Partnr.OEM:	Pos.nr:
MA.10.001	Bushing S.S.	0586.0012.A01.99	10
MA.10.002	Shaft S.S.	0586.0000.031.15	9
MA.10.003	Roller	0586.0000.033.15	10
MA.10.004	Roller	0586.0012.A02.99	
MA.10.005	Bushing S.S.	0586.0012.A03.99	7
MA.10.007	Gearwheel	0990.IDT1.028.00	4
MA.10.008	Gear Rack Set	0586.0000.000.99	8
MA.10.009	Wearing Plate	0568.0000.022.15	3
MA.10.011	Roller, special 6202	0990.LR00.000.02	
VE.DR.019	Compression spring	0990.V006.051.00	9

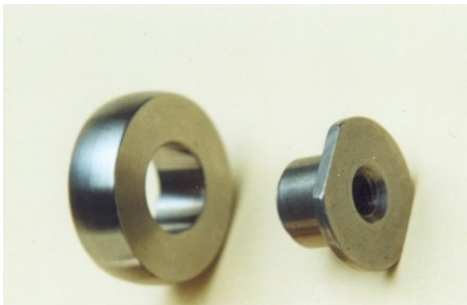

MA.10.004

MA.10.001



MA.10.005

MA.10.007 MA.10.002 MA.10.003 MA.10.008

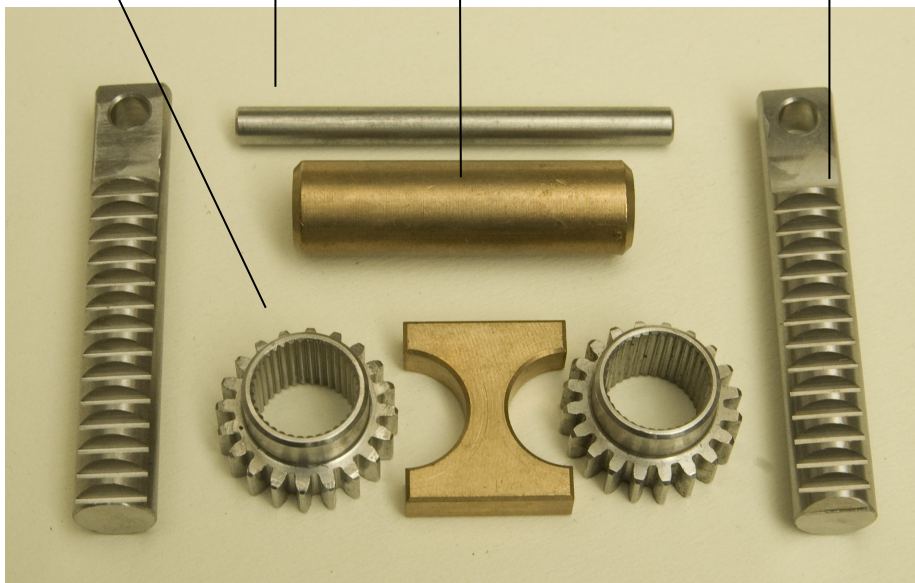

MA.10.009



MA.10.011



VE.DR.019

Panconveyor compatible with Meyn



Rodon Int. nr:	Description:	Partnr.OEM:	Pos.nr:
PC.10.001	Mounting pin, incl circlip	0803.0000.001.66	
PC.10.002	Tray, synthetic grey 6"	0587.0040.008.00	
PC.10.004	Tray, synthetic green 6"	0587.0040.009.00	
PC.10.005	Tray, synthetic grey 8"	0587.0040.005.00	
PC.10.006	Tray, synthetic green 8"	0587.0040.014 .00	
PC.10.007	Tray, synthetic red 6"	0587.0040.010.00	
PC.10.008	Tray, synthetic blue 6"		
TR.HB.001	Chain 50,8 S.S.with synth. Rollers	89.2931.011.0009	
TR.HB.002	Connecting link 50,8 S.S.	89.2936.011.0013	
TR.HB.003	Chain 50,8 S.S. with s.s. rollers		



Eviscerating machine compatible with Stork

Various parts



Rodon Int. nr:	Description:	Partnr.OEM:	Pos.nr:
EV.20.001	Collar bearing bushing 12x15 L=9	09.0100.322/4R.552.458	Pos. 543
EV.20.002	Collar bearing bushing 18x6 L=12	4R.554.549	Pos. 527
EV.20.003	Adjusting ring	00.0950.358	Pos. 548
EV.20.004	Roller S.S.	4R.554.542	Pos. 517
EV.20.005	Curveroller S.S.	4R.522.517	Pos. 505
EV.20.006	Shaft 10x50	4R.516.680	Pos. 519/19
EV.20.007	Brass ring 18x10,5x1	4R.448.830	Pos. 532
EV.20.008	Ring 30x16x1	4R.434.706	Pos. 533
EV.20.009	Shaft	4R.516.683	Pos. 521
EV.20.010	Intermediate bushing SS	4R.531.389	Pos. 534
EV.20.011	Intermediate bushing SS	4R.554.263	Pos. 602
EV.20.012	Support lowerunit Alu.	3R.544.265	Pos. 605
EV.20.013	Strip	3M.662.512	Pos. 026
EV.20..501	S.S. rol incl. synth bushing	4R.678.186	
EV.20.015	Shaft 8x35	4M.631.617	Pos. 038
EV.20.016	Shaft 6x21	4M.631.638	Pos. 041
EV.20.017	Ring 18/10x1	4R.544.354	Pos. 032
EV.20.018	Curve roller	00.3425.959	Pos. 005
EV.20.019	Rod	4R.554.544	Pos. 018
EV.20.020	Ratchet	3R.531.379	Pos. 002
EV.20.021	Strip HL	3M.602.839	Pos. 025
EV.20.022	Strip HL	3M.602.840	Pos. 026
EV.20.023	Bush	4M.631.348	Pos. 028
EV.20.024	Eye bolt M8 S.S.	4M.631.639	
EV.20.025	Slide	1M.631.505	
EV.20.026	Ring D9x22x5 S.S.	2R.530.908	
EV.20.027	Ring D6,5x22x5 S.S.	4R.542.375	
EV.20.028	S.S. Pin	4R.542.471	
EV.20.029	Strip L=755 PGI	3960787	
EV.20.501	S.S. rol incl. synth bushing	4R.678.186	
EV.20.502	Bracket	3R.579.773	

Eviscerating machine compatible with Stork

Various parts



EV.20.001



EV.20.002



EV.20.003



EV.20.005



EV.20.006

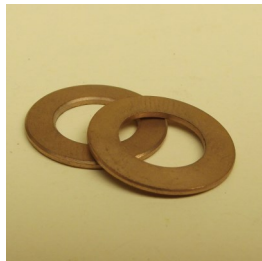

EV.20.007

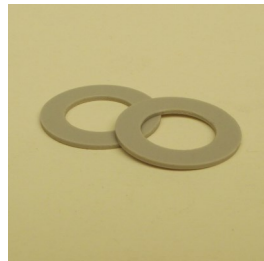

EV.20.008



EV.20.009



EV.20.010



EV.20.015

EV.20.016



EV.20.017



EV.20.018



EV.20.019

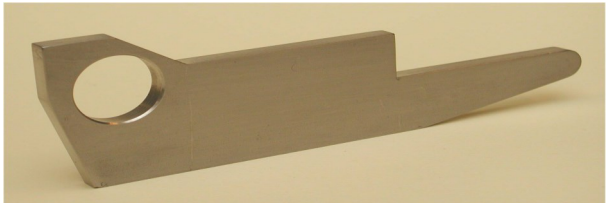

EV.20.020



EV.20.026



EV.20.027



EV.20.502

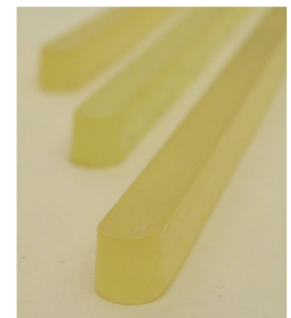

EV.20.022

Eviscerating machine compatible with Stork Separator strip Nutech system



Rodon Int. nr:	Description:	Partnr.OEM:	Pos.nr:
VC.20.018	Separator strip Nutech system	4M 602 839 / 4M 602 840	

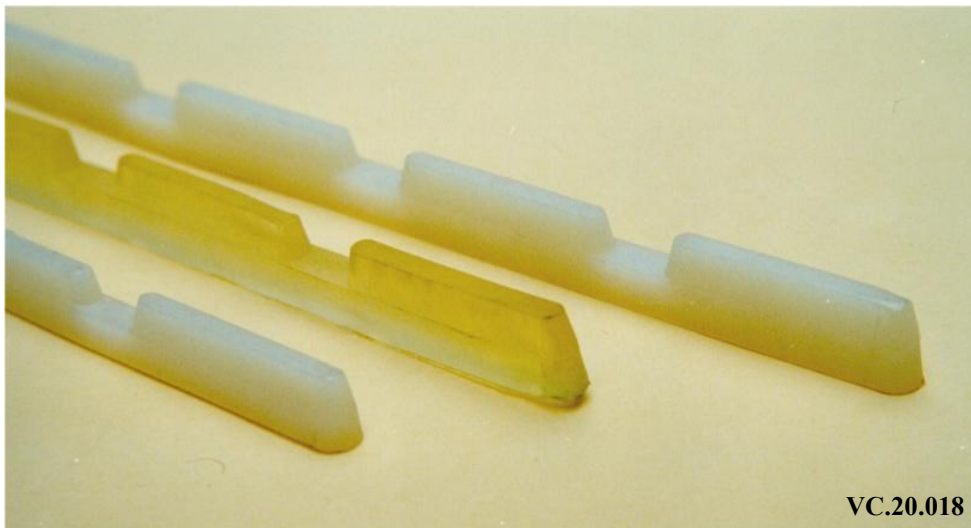

Final Control Machine compatible with Stork

Various parts



Rodon Int. nr:	Description:	Partnr.OEM:	Pos.nr:
FC.20.001	Bearing bushing	4R.511.563	115
FC.20.002	Plug	4R.501.506	103
FC.20.003	Roller 31x16x13	4R.448.815	118
FC.20.004	Bearing bushing 16/12x13	4R.509.144	119
FC.20.005	Bushing	4R.501.414	120
FC.20.006	O-ring	00.2173.330	
FC.20.007	Bushing synthetic	4R.500.563	
FC.20.008	Bushing synthetic	4R.500.564	107
FC.20.009	Roll synthetic	4R.561.130	01 (Rodon pos.)
FC.20.010	O-ring 69,52x2,62	00.2178.214	



FC.20.001

FC.20.005



FC.20.004



FC.20.002

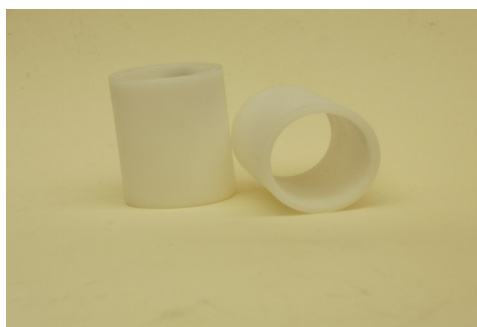

FC.20.006



FC.20.007



FC.20.008



FC.20.009

FC.20.003

Final Control Machine compatible with Meyn Suction head / Bend suction pipe



Rodon Int. nr:	Description:	Partnr.OEM:	Pos.nr:
FC.10.002	Suction head	0071.0000.019.00 – 071.00.019	33/65/66
FC.10.008	Slide block	0990.BL00.004.00 – 071.00.018	31/58
FC.10.012	Bend suction pipe	0990.PK20.000.03 – 071.00.025	32
FC.10.013	Suction pipe	0990.PK20.000.06	35
FC.10.014	Guidance pipe L=195mm	0990.PK19.002.00 - 071.00.009	46
FC.10.015	Centringbracket S.S.	0071.0000.000.10 - 071.00.010	115
FC.10.001	Connection tuhe rubber	0990.A206.001.00	36
FC.10.003	Sealing ring	89.3538.154.0002	34



FC.10.002



FC.10.008



FC.10.014



FC.10.015



FC.10.013



FC.10.012



FC.10.001



FC.10.003

Final Inspection Machine compatible with Meyn Slide unit



Rodon Int. nr:	Description:	Partnr.OEM:	Pos.nr:
FC.10.501	Slide unit complete	0071.0000.000.99	
SA.10.005	Intermediate shaft L=425	0990.A005.005.00	29
LB.KU.002	Bearing bushing L=60 synth.	0990.A202.011.00	30
FC.10.008	Slide block	0990.BL00.004.00	31
FC.10.012	Bend suction pipe	0990.PK20.000.03	32
FC.10.002	Suction head	0071.0000.019.00	33
FC.10.003	Sealing ring	89.3538.154.0002	34
FC.10.013	Suction pipe	0990.PK20.000.06	35
FC.10.001	Connection tube rubber	0990.A206.001.00	36
NC.10.013	Spacer	0990.A200.001.00	37
1002.0000.SS13	Ball bearing SS	89.0691.017.0006	38
1001.7991.1030	Countersunk headscrew S.S.	89.1126.015.004	39

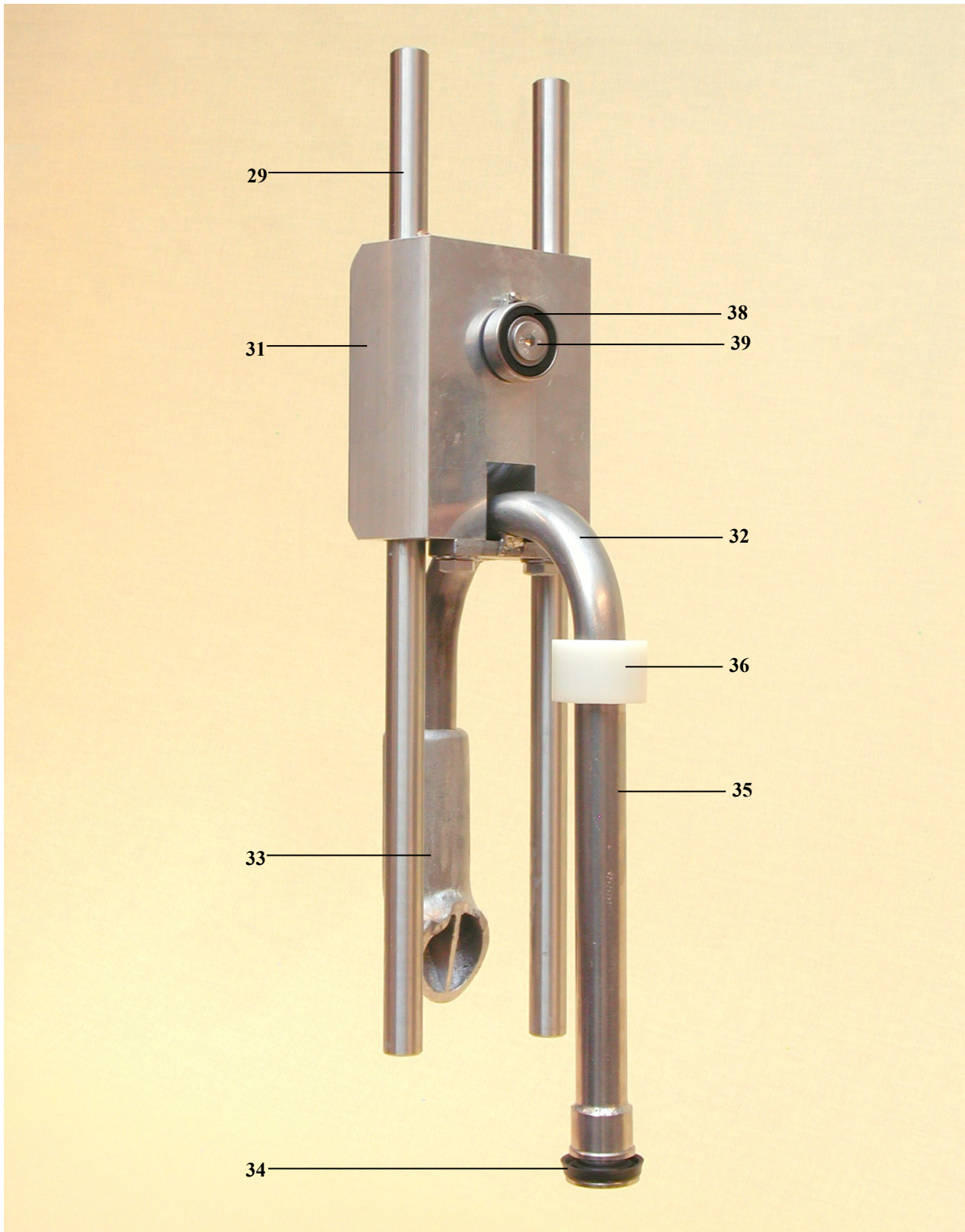

Final Inspection Machine compatible with Meyn Vacuum unit



Rodon Int. nr:	Description:	Partnr.OEM:	Pos.nr:
FC.10.502	Vacuum unit complete	0990.PK37.00.67	
1001.0912.0825	Bolt S.S.	89.1105.015.0005 - 99.11450	2
FC.10.016	Lock, brass	0990.PK37.025.00	3
FC.10.022	Shaft S.S.	0990.PK37.019.00	4
1001.0933.0516	Bolt S.S.	89.0802.015.0006	5
FC.10.017	Mounting bracket	0990.PK37.024.00	6
1001.0916.0820	Adjusting screw SS	89.1145.015.0005	7
FC.10.018	Hinge SS	0990.PK37.000.15	8
LBK15/19x25	Collar bearingbushing	89.0655.045.004	9
FC.10.019	Shaft S.S.	0990.PK37.020.00	10
1001.0931.0855	Bolt S.S.	89.0864.015.0003	11
1001.0912.0608	Bolt S.S.	89.1104.015.0003	14
FC.10.020	Thread tube S.S.	0990.A205.067.00	20
1001.0933.0620	Tap bolt S.S.	89.0803.015.0006	25
FC.10.021	Block plate S.S.	0990.PK37.049.00	27
VE.DR.039	Compression spring dr=0,8	89.3011.019.0121	28
1002.0000.3000	Ball S.S.	89.0699.011.0001	29

Final Inspection Machine compatible with Meyn Vacuum unit

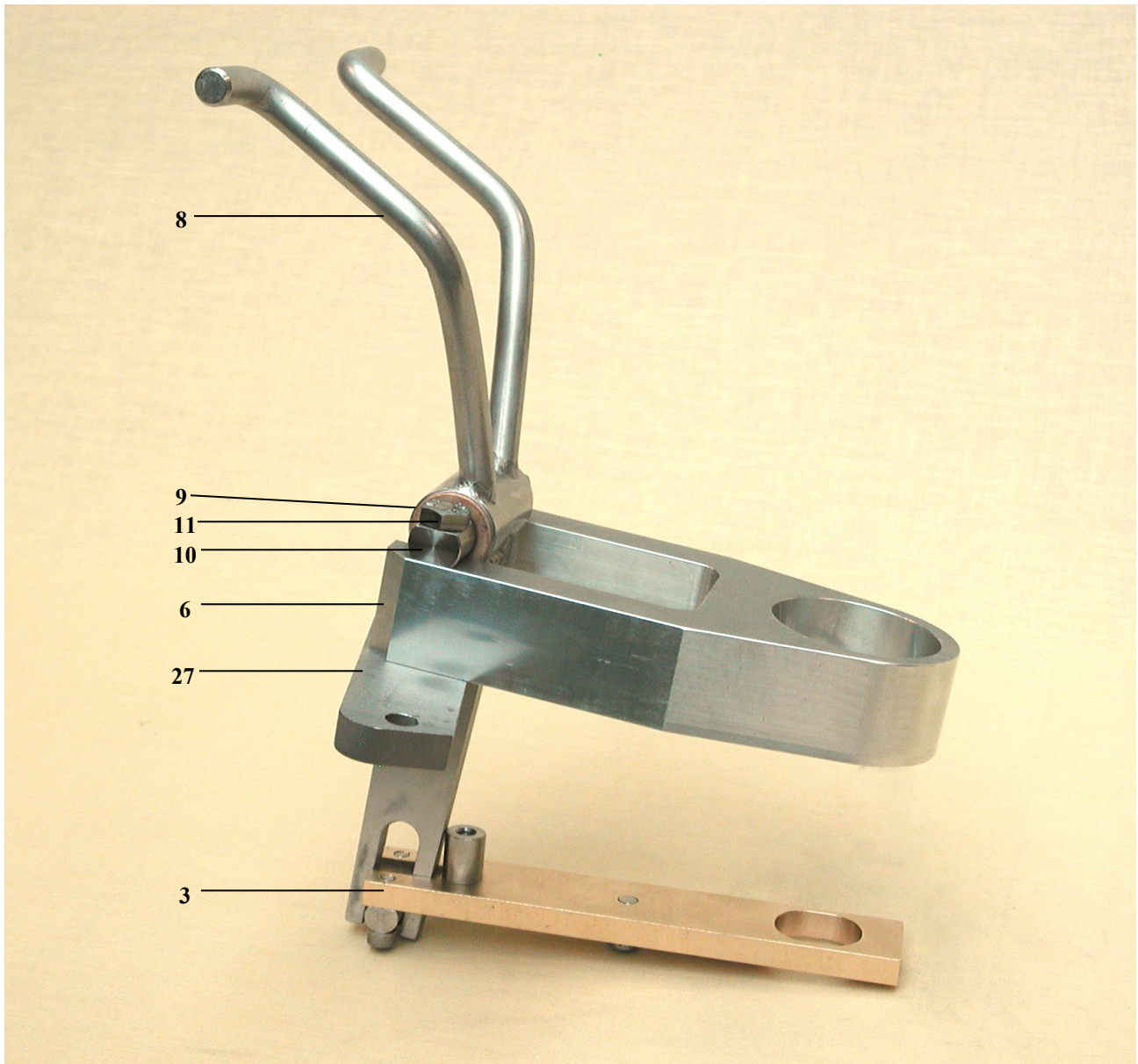

Final Control Machine compatible with Meyn Reconditioned Parts



Rodon Int. nr:	Description:	Partnr.OEM:	Pos.nr:
FC.RE.501	Complete unit reconditioned	0071.0000.000.99	118/30-39
FC.10.501	Complete unit new	0071.0000.000.99	118/30-39
FC.RE.013	Suction pipe	0990.PK20.000.06-071.00.071	35
FC.RE.014	Guidance pipe L=195 mm	0990.PK19.002.00-071.00.009	46/66-471

FC.RE.501



FC.RE.013

FC.RE.014

Inside/Outside Birdwasher compatible with Meyn Spray Segment



Rodon Int. nr:	Description:	Partnr.OEM:	Pos.nr:
IO.10.001	Spray segment 14 units	0990.PK09.004.00	
IO.10.009	Spray segment 10 units	0990.PK09.003.00	
IO.10.010	Spray segment 16 units	0990.PK09.005.00	



IO.10.009

Inside/outside bird washer compatible with Meyn
Complete unit



Rodon Int. nr:	Description:	Partnr.OEM:	Pos.nr:
IO.10.502	Complete unit 14 units	0990.PK13.000.02	
LB.KU.002	Bearing bushing L=60 synth	0990.A202.011.00	41
1001.7991.1030	Countersunk headscrew S.S.	89.1126.015.0004	50
1002.0000.SS13	Ball bearing SS	89.0691.017.0006 - 99.22848	49
NC.10.013	Spacer	0990.A200.100.00 - 990.0564	48
IO.10.003	Water pipe 14 units	0990.PK.02.000.36 - 065.06.020	46
1001.0912.0620	Bolt SS	89.1104.015.0007 - 99.11425	44
IO.10.002	Slide block	0990.BL00.002.00 - 065.00.006	43
IO.10.013	Connectingnipple 1/4" BSP	89.2541.040.0009 - 99.20534	42
IO.10.012	Pipe	0990.PK02.000.037 - 065.00.004	39
SA.10.007	Intermediate shaft L=505	0990.A005.005.00 - 990.4253	38
IO.10.501	Connecting piece	0990.PK00.004.00 - 065.00.052	40
IO.10.004	Coil sprayer 1/4" Brass	89.2435.010.0006 - 99.17685	37
IO.10.005	Spray head	0990.PK.00.000.02 - 065.00.005	36
IO.10.008	Hose 610mm	89.2463.900.0004 - 99.20724	35

Inside/outside bird washer compatible with Meyn Complete unit

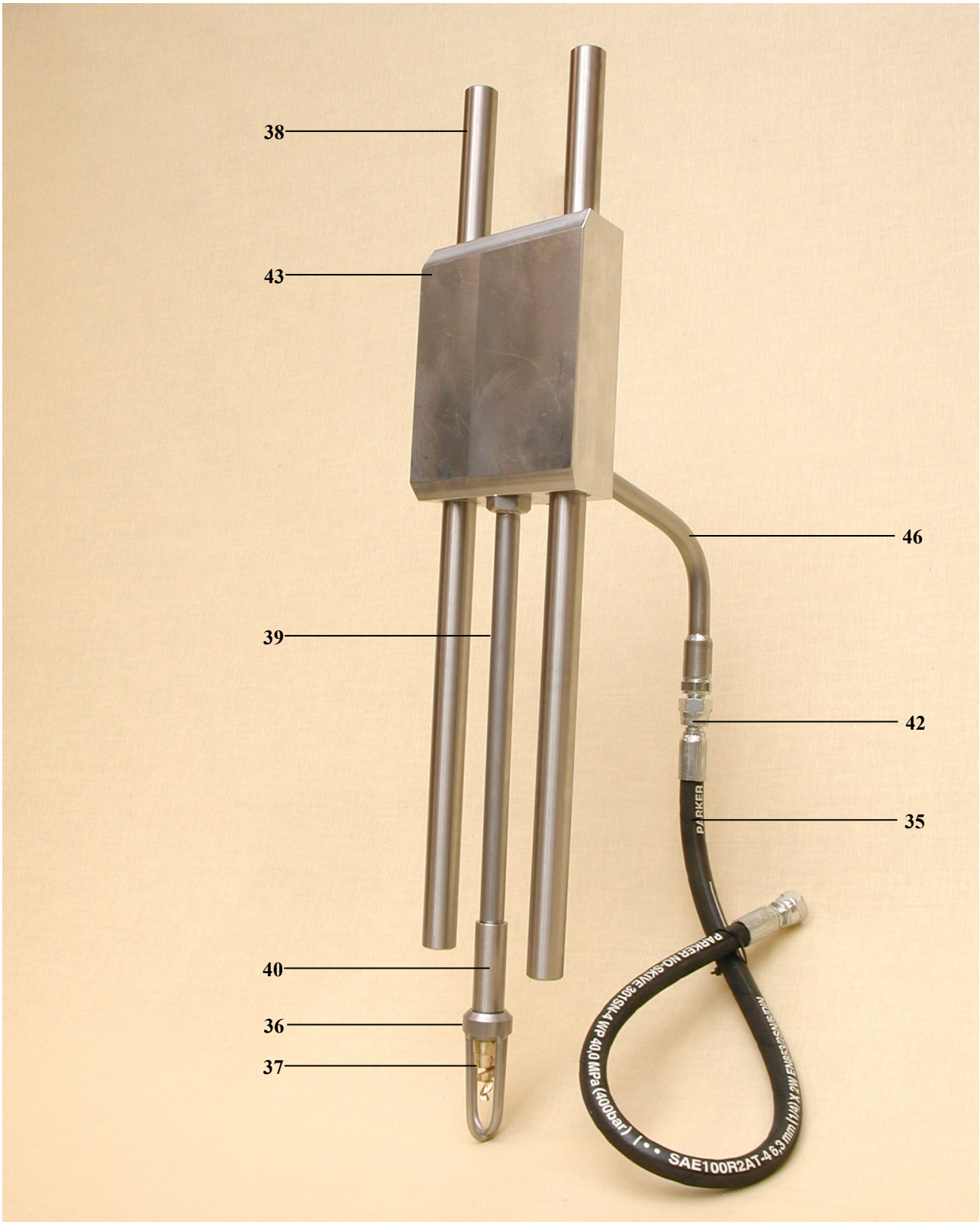

Inside/Outside Birdwasher compatible with Meyn Reconditioned Parts



Rodon Int. nr:	Description:	Partnr.OEM:	Pos.nr:
IO.RE.502	Complete unit reconditioned 14-20 units	0990.PK13.000.02 – 065.06.055	35-50



Neckbreaker / Neckskin Slitter compatible with Meyn Reconditioned Parts



Rodon Int. nr:	Description:	Partnr.OEM:	Pos.nr:
NC.RE.501	Complete breaking unit (model NC)	0990.PK36.000.02	
EV.RE.	Centering brackets ev. machines		

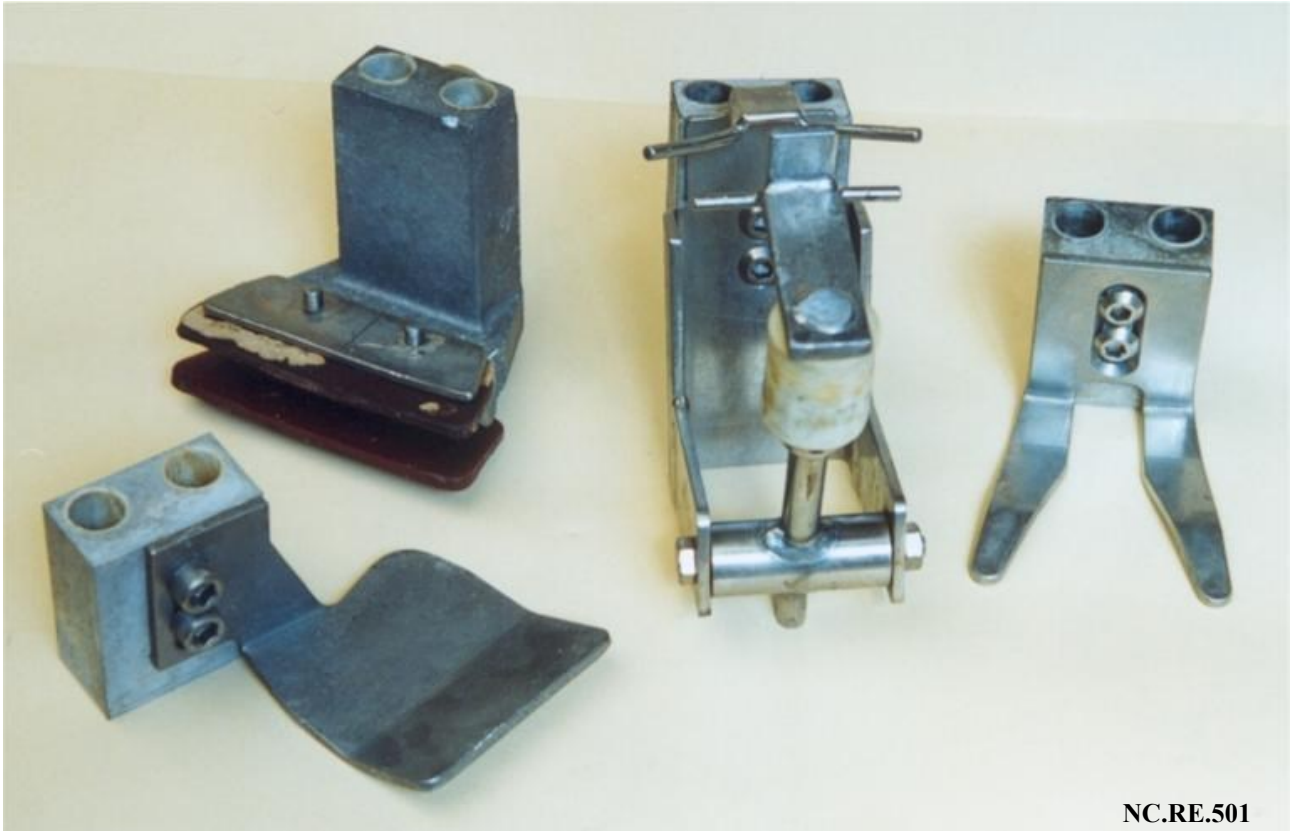

Neckbreaker compatible with Meyn Complete unit NCB



Rodon Int. nr:	Description:	Partnr.OEM:	Pos.nr:
NC.10.505	Complete unit NCB	0990.	
SA.10.004	Intermediate shaft	0990.A005.010.00	30
NC.10.007	Slide block	0990.BL00.007.00	45
NC.10.010A	Neck bracket	0990.PK36.001.03	46
NC.10.016	Bolt S.S.	0990.A800.003.00	47
1001.7991.1030	Countersunk headscrew S.S.	89.1126.015.0004	49
1002.0000.SS13	Ball bearing SS		50
NC.10.013	Spacer	0990.A200.001.00	51
NC.10.015	Bracket unit new style NCB	0990.PK35.	53
LB.KU.001	Bearing bushing L=30 synth.	0990.A202.010.00	54
1001.0931.1090	Bolt S.S	89.0685.015.0017	55
1001.0934.0010	Nut S.S.	89.0901.015.0007	56
LBC16/20X20	Bearing bushing L=20	89.0634.045.0004	57
NC.10.004	Spacer sleeve	0990.A207.002.00	116
NC.10.003	Roller	0990.AB00.004.00	117
1001.0933.1020	Bolt		120
NC.10.005	Spacer sleeve	0990.A700.012.00	121
NC.10.002	Washer	0990.A703.010.00	122
NC.10.001	Chisel	0990.PK36.003.04	123
NC.10.501	Pivot arm	0990.PK36.000.05	124
NC.10.006	Spacer sleeve	0990.A202.018.00	127

Meyn Neckbreaker Complete unit NCB

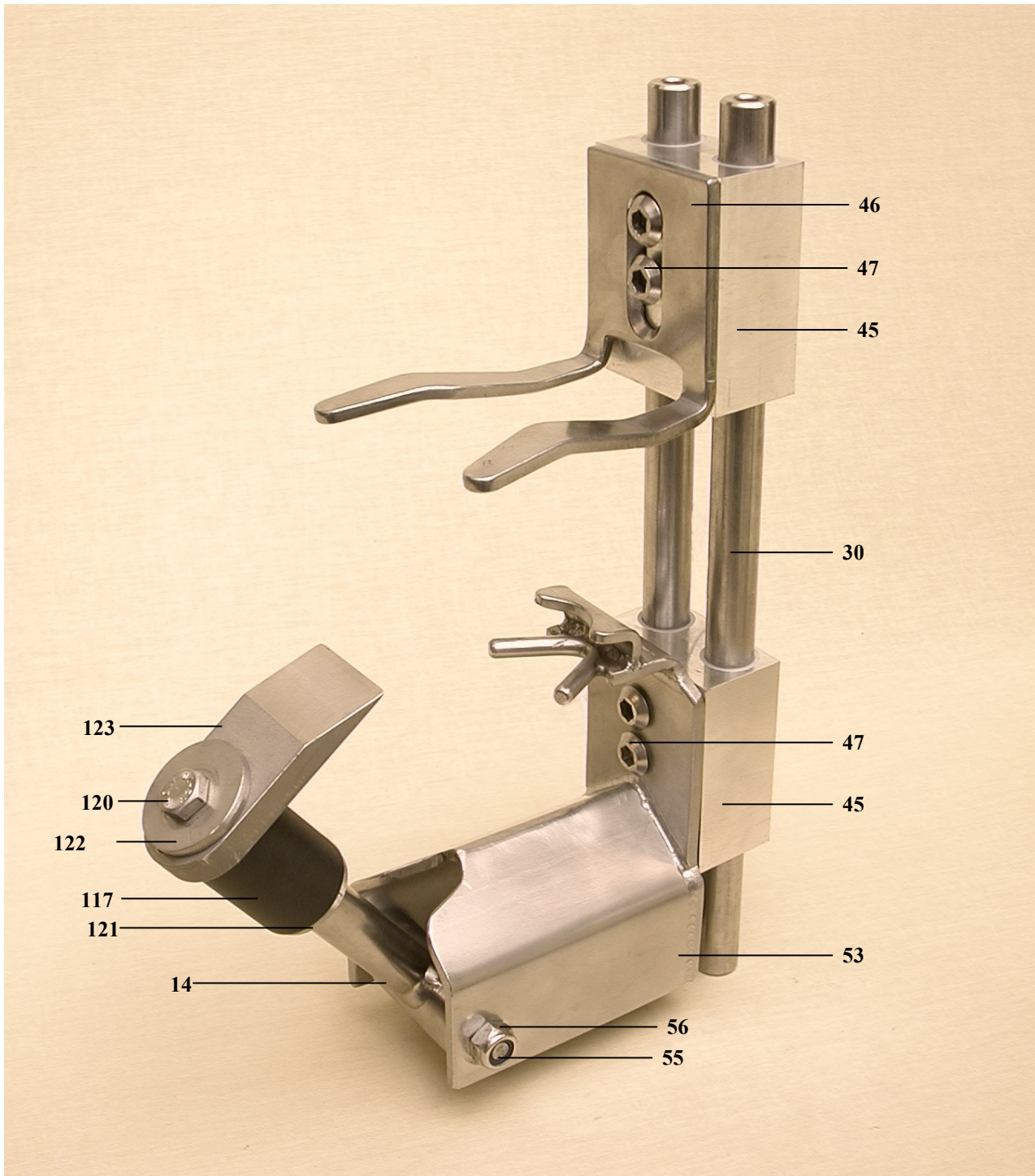

Drop-Off stations compatible with Meyn Ejecting pin



Rodon Int. nr:	Description:	Partnr.OEM:	Pos.nr:
AS.10.501	Ejecting pin M 8 D=8 145x145	0115.000.00.0000	
AS.10.502	Ejecting pin M10 D=8 145x145	0115.000.00.0000	
AS.10.503	Ejecting pin M10 D=8 134x200	0115.000.00.0000	

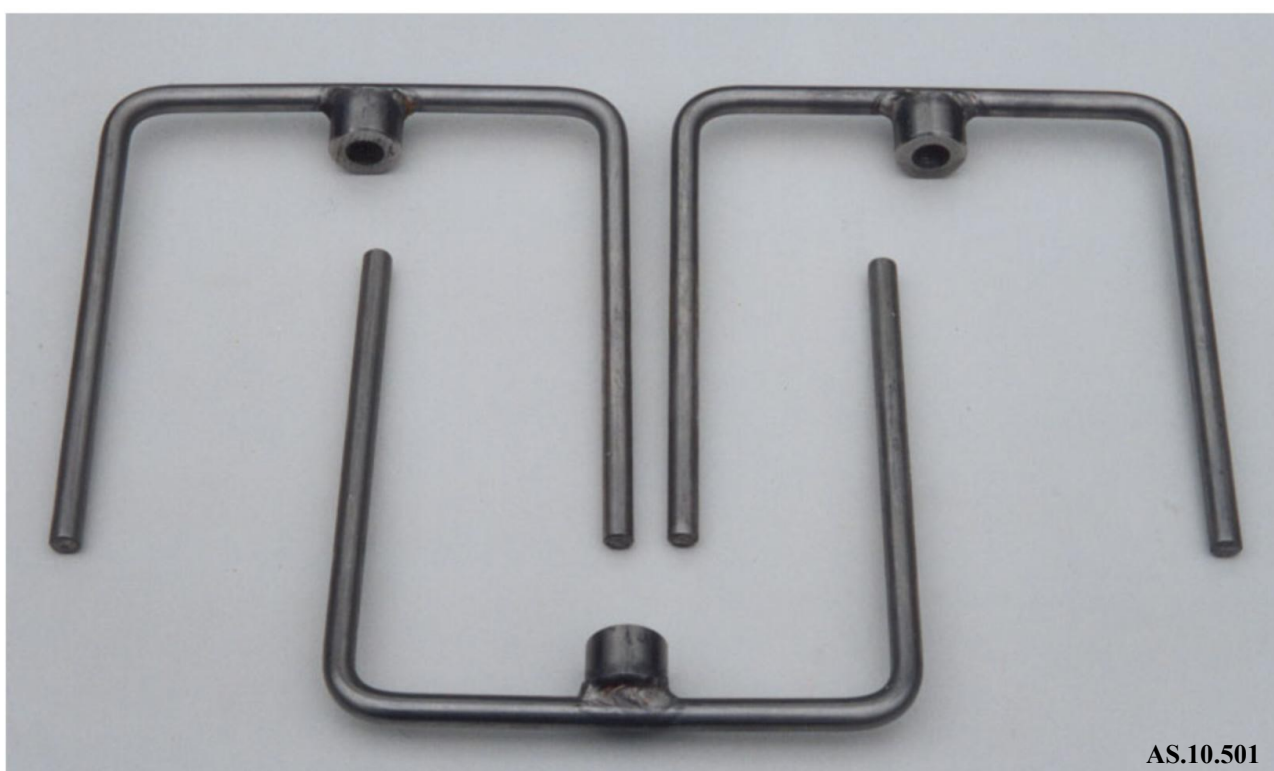

Automatic Rehanger compatible with Meyn Belt wheel / Draw spring



Rodon Int. nr:	Description:	Partnr.OEM:	Pos.nr:
RH.10.008	Belt wheel	0990.AD04.001.00-154.00.038	140
VE.TR.002	Draw spring – rehanger kill/ev line – rehanger ev/chill line	0990.V000.018.00 – 992.7517	51 172



Automatic Rehanger compatible with Meyn Pawls



Rodon Int. nr:	Description:	Partnr.OEM:	Pos.nr:
RH.10.502	Pawl (rehanger ev/chill line)	0990.OH20.000.02-228.00.350	
RH.10.503	Pawl (rehanger ev/chill line)	0990.OH20.000.01-228.00.044	
RH.10.505	Pawl for RH turning wheel (def/ev)	0990.OH20.000.03	85
RH.10.506	Pawl for LH turning wheel (def/ev)	0990.OH20.000.04	85

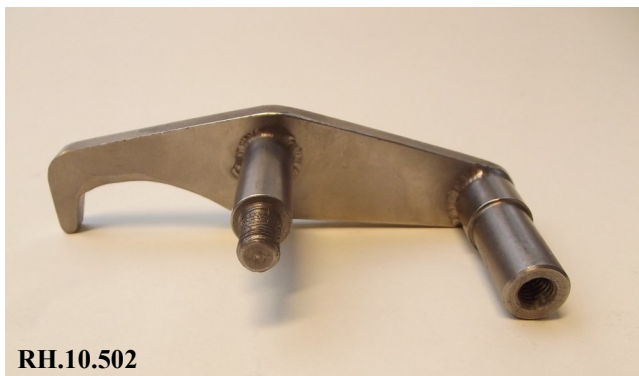

Automatic Rehanger compatible with Meyn

Various parts



Rodon Int. nr:	Description:	Partnr.OEM:	Pos.nr:
RH.10.004	Pawl roller for ev/chill line	0990.AB00.003.00-228.00.049	127
RH.10.005	Spring roller for ev/chill line	0990.OH21.004.00-228.00.048	126
RH.10.009	Collar bushing	0990.OH21.005.00 – 990.0613	87
RH.10.011	Pawl roller for kill/ev line	0990.AB00.002.00 – 990.0857	98
RH.10.012	Spring roller for kill/ev line	0990.OH21.026.00 – 990.0858	97
RH.10.016	Pin in behalf of spring	0990.OH21.007.00 – 990.0033	92
VE.TO.003	Torsion spring kill/ev LH wheel	0990.V002.021.00 – 992.7587	93
VE.TO.004	Torsion spring kill/ev RH wheel	0990.V002.022.00 – 992.7588	93
VE.TO.005	Torsion spring ev/chill LH wheel	0990.V002.001.00 – 992.7548	117
VE.TO.006	Torsion spring ev/chill RH wheel	0990.V007.008.00 – 992.7549	118



RH.10.004



RH.10.005



RH.10.009



RH.10.011



RH.10.012



RH.10.016

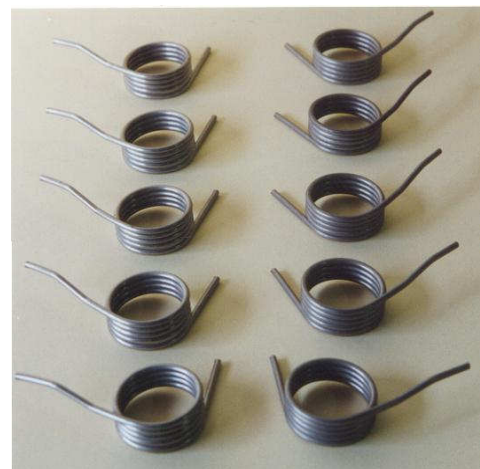

VE.TO.005

VE.TO.006

Automatic Rehanger compatible with Meyn

Various parts



Rodon Int. nr:	Description:	Partnr.OEM:	Pos.nr:
RH.10.018	Support roller D=40mm bore=13mm	0990.OH45.003.36	03
RH.10.019	Roller D=22mm	0990.OH45.001.35	14
RH.10.020	Roller D=26mm	0990.OH45.005.25	05
RH.10.022	Roller	0990.OH45.055.00	9A
RH.10.023	Roller	0990.AB11.218.00	6
RH.10.031	Carrier plate chill/weighing line	0990.OH45.030.00	
RH.10.032	Carrier plate weighing/cut-up line	0990.OH45.002.36	
RH.10.033	Support roller D=33mm	0990.OH45.013.00	
RH.10.034	Distance ring		
RH.10.035	Distance ring	0990.OH45.011.27	
1002.0000.0016	Ball bearing 626	89.0691.017.0020 - 89.0691.065.0035	



RH.10.018



RH.10.019



RH.10.020/023



RH.10.032

RH.10.031



RH.10.033



RH.10.034



RH.10.035

Automatic Rehanger compatible with Meyn Synthetic rails, cutting ring and carrier wheel



Rodon Int. nr:	Description:	Partnr.OEM:	Pos.nr:
RH.10.001	Cutting ring	0990.NR02.004.00-154.01.194	176
RH.10.029	Bearing (grooved)	0990.OH45.057.00- 89.3965.904.0005 89.3965.904.0006	11
RH.10.030	Synthetic rail D=1001 mm	0990.OH48.001.47	01
RH.10.037	Synthetic rail D=800 mm	0990.OH48.024.00	01
RH.10.039	Carrier wheel RH/LH		178



RH.10.030/037



RH.10.001



RH.10.029



RH.10.039

Automatic Rehanger compatible with Meyn Aluminium plate and levers



Rodon Int. nr:	Description:	Partnr.OEM:	Pos.nr:
RH.10.054	Plate	0990.0H45.001.58	
RH.10.055	Lever	0990.0H45.003.50	
RH.10.056	Lever	0990.0H45.004.50	

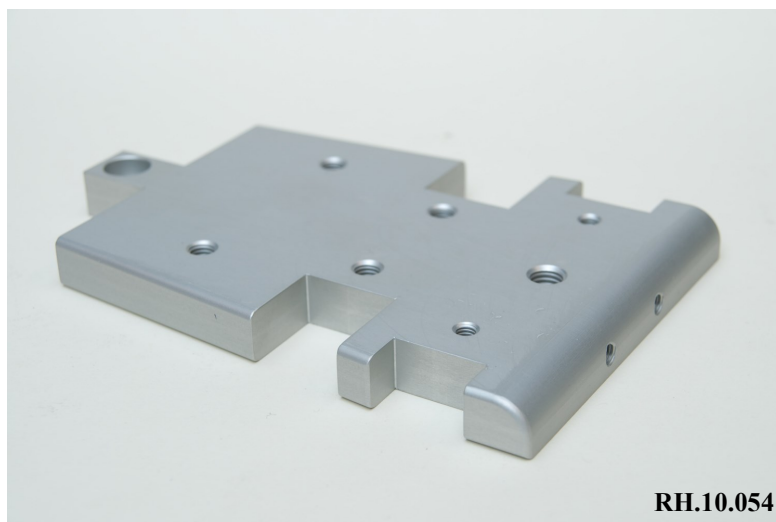

Ejection unit 12mm compatible with Meyn



Rodon Int. nr:	Description:	Partnr.OEM:	Pos.nr:
RH.10.510	Ejection unit 12mm	0990.OH07.000.59	

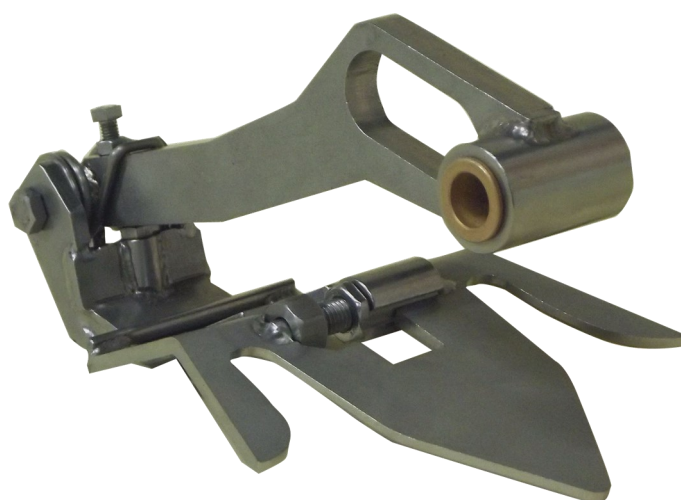
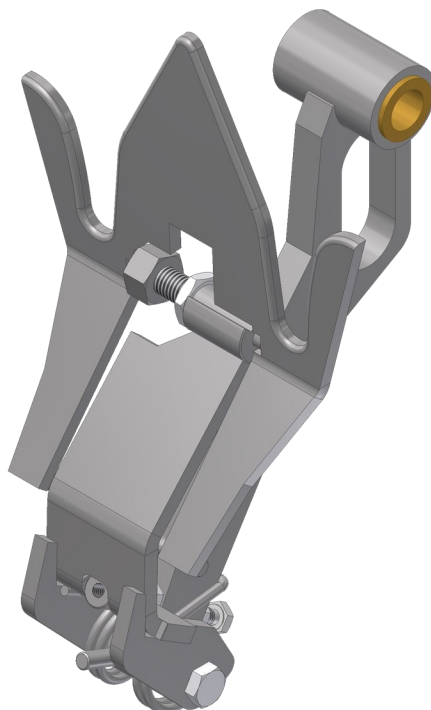

Automatic Rehanger compatible with Stork

Various parts



Rodon Int. nr:	Description:	Partnr.OEM:	Pos.nr:
RH.20.003	Support roller	4R 557 143	109
RH.20.004	Bearing for support roller	09.0100.002	118
RH.20.005	Carrierplate	4R 523 665	904/1104
RH.20.006	Carrierplate	4M 661 227	
RH.20.007	Carrierplate	4R 561 796	107
RH.20.017	Bearing for support roller	09.0101.180	26
RH.20.039	Rollerbearing assy D=34	09.0101.214	(Rodon pos.01)
RH.20.048	Carrierplate 140x80x8 TRDE-NT Right		
RH.20.049	Carrierplate 140x80x8 TRDE-NT Left		
RH.20.050	Carrierplate 143x40x6 TRDE-NT		

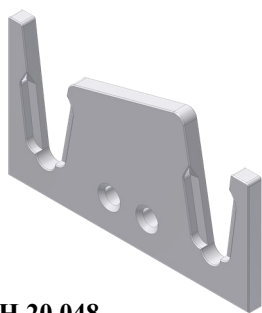

RH.20.048

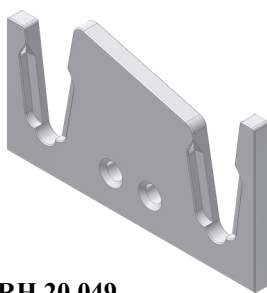

RH.20.049

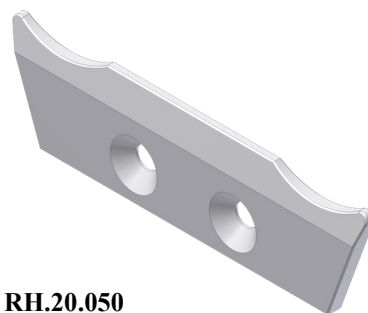

RH.20.050



RH.20.003



RH.20.017



RH.20.004



RH.20.039

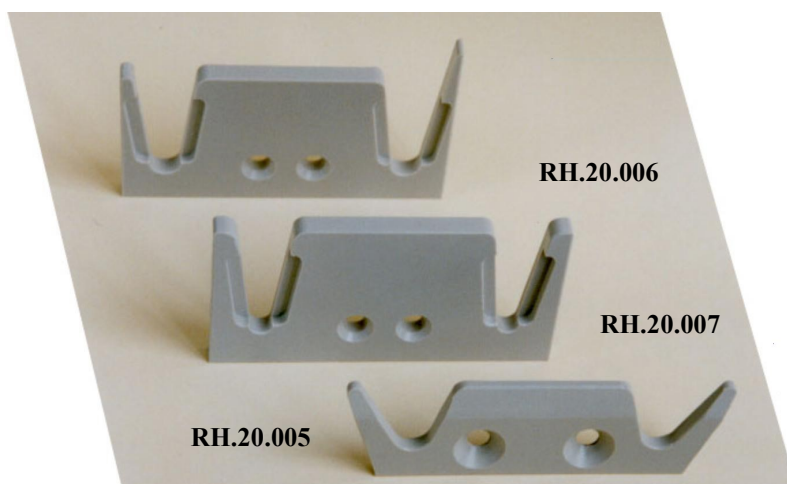

RH.20.006

RH.20.007

RH.20.005

Automatic Rehanger compatible with Stork

Various parts



Rodon Int. nr:	Description:	Partnr.OEM:	Pos.nr:
RH.20.011	Support roller	4R.575.564	10
RH.20.012	Bushing	4R.557.144-4R.604.069	108/122
RH.20.014	Collar bearingbushing synth.	4M.614.485	944
RH.20.015	Bearing bushing S.S.	4R.522.737	907
RH.20.020	Plate S.S. 130x120x6	3M.635.703	1
RH.20.021	Bushing S.S.	4M.608.987	14
RH.20.026	Pin S.S.	4M.614.841	3
RH.20.027	Block S.S.	4M.635.696	9
RH.20.029	Friction block	4M.669.425	5

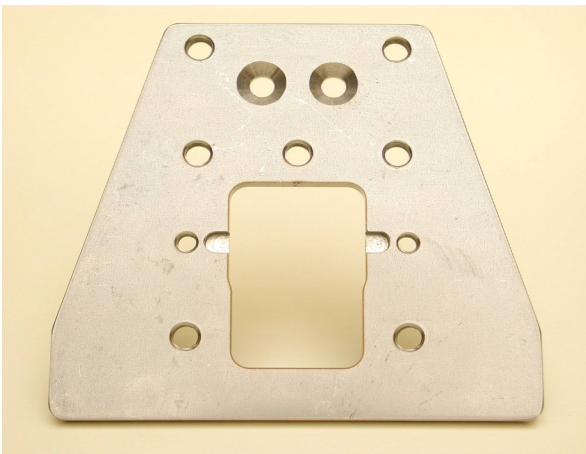

RH.20.020



RH.20.015

RH.20.012

RH.20.021



RH.20.011



RH.20.014



RH.20.026



RH.20.027



RH.20.029

Buffer Rehanger compatible with Stork Carrierblock



Rodon Int. nr:	Description:	Partnr.OEM:	Pos.nr:
RH.20.001	Carrierblock	3R 604 175	103
RH.20.002	Carrierblock	3M 616 116	
RH.20.008	Carrierblock	3R 579 640	105
RH.20.009	Carrierblock	3R 587 251	103
RH.20.051	Carrierblock 80x25x8		
RH.20.052	Carrierblock 75x32x16	679.093	
VE.DR.012	Compression spring	4M 625 105	8/102

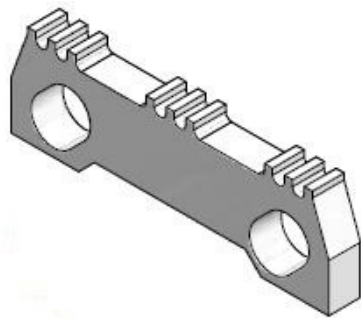
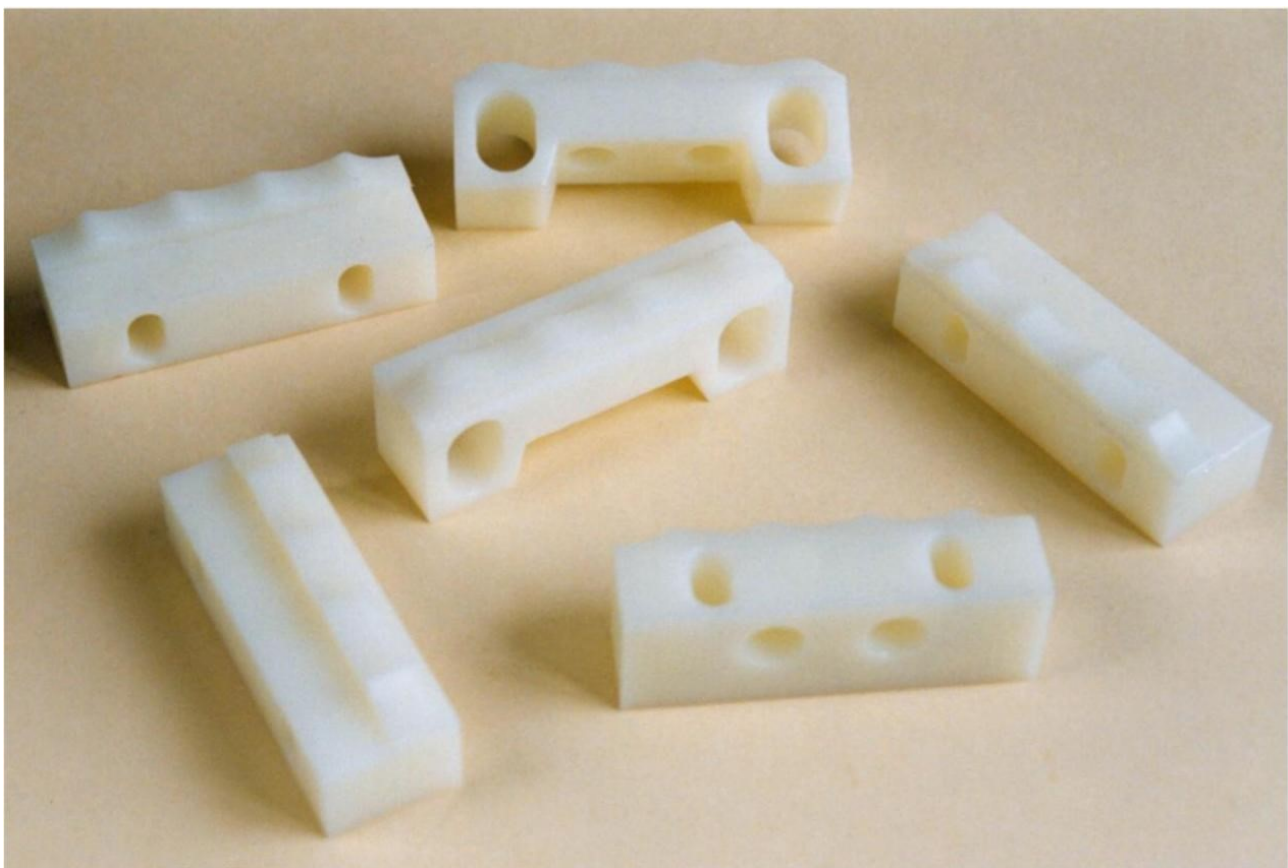

RH.20.051

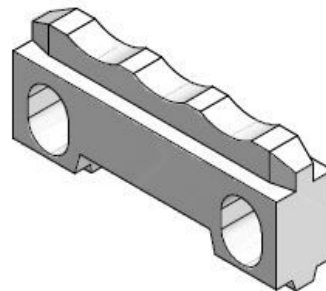

RH.20.052

ACM Cut-up System compatible with Stork Wing and strip



Rodon Int. nr:	Description:	Partnr.OEM:	Pos.nr:
DM.20.001	Wing RH	3R 579 447	309
DM.20.002	Wing LH	3R 579 448	310
DM.20.003	Strip	3R 534 631	

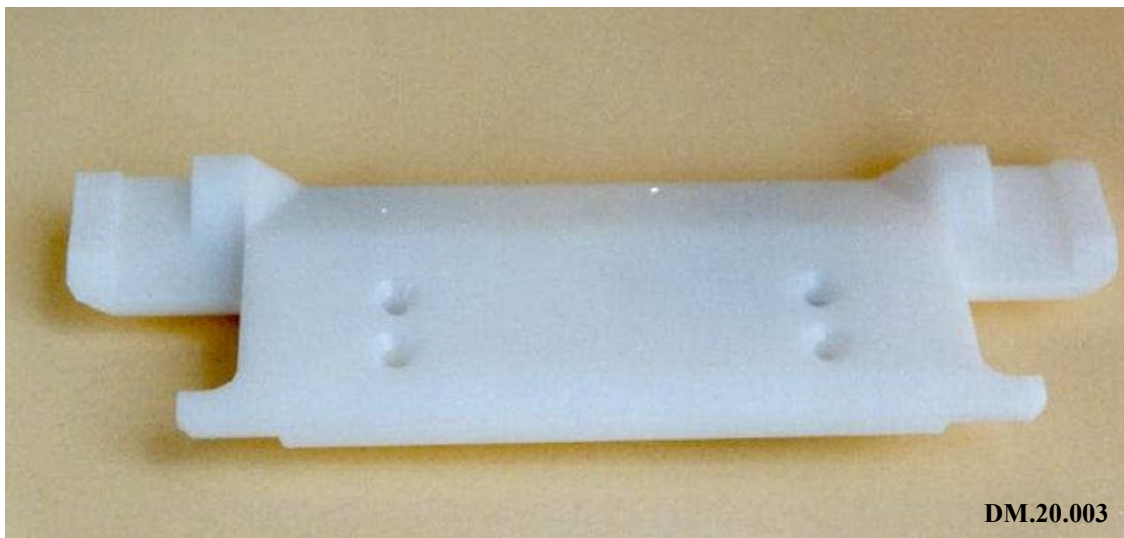
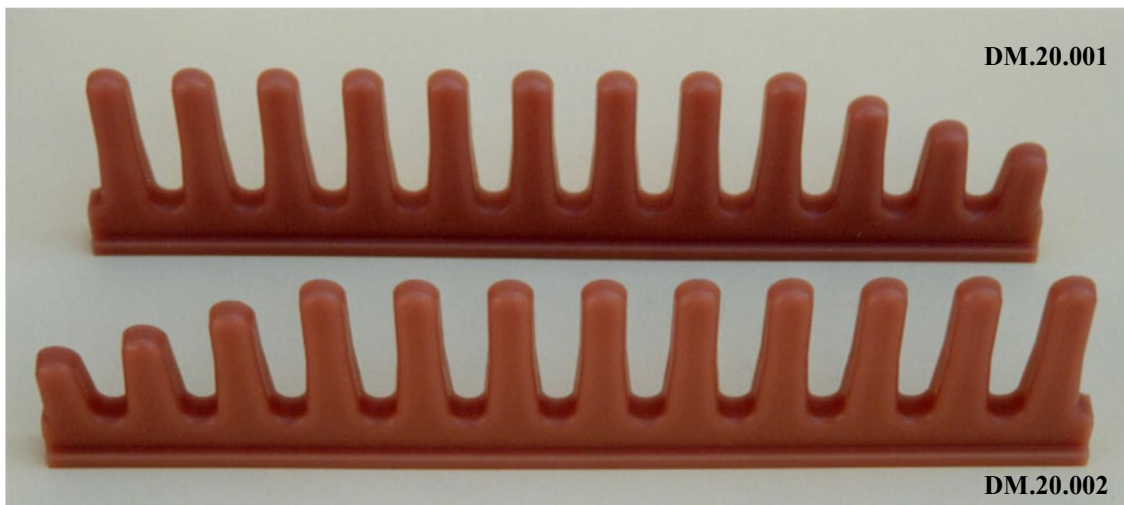

Giblet pump compatible with Meyn Diaphragmpump 3”



Rodon Int. nr:	Description:	Partnr.OEM:	Pos.nr:
GP.10.500	Diaphragmpump 1.1 kW 1.000rpm		
	Other versions also available		



Giblet pump compatible with Meyn Diaphragm pump /Spares



Rodon Int. nr:	Description:	Partnr.OEM:	Pos.nr:
GP.10.001	Diaphragm 3"	89.3751.900.0002	56
GP.10.002	Diaphragm 4"	89.3751.900.0003	56
GP.10.003	Suction/discharge valve	89.3751.900.0004	65
GP.10.005	Diaphragm axle	89.3751.900.0015	53
GP.10.006	Filling disc	89.3751.900.0018	44
GP.10.007	Excentric	89.3751.900.0008	43
GP.10.031	Suction head connector	89.3751.900.0000	
GP.10.032	Discharge head connector	89.3751.900.0000	
GP.10.033	Suction/discharge valve		
GP.10.036	Diaphragm axle new style		
GP.10.043	Cover 3" PVC		

Other parts are also available

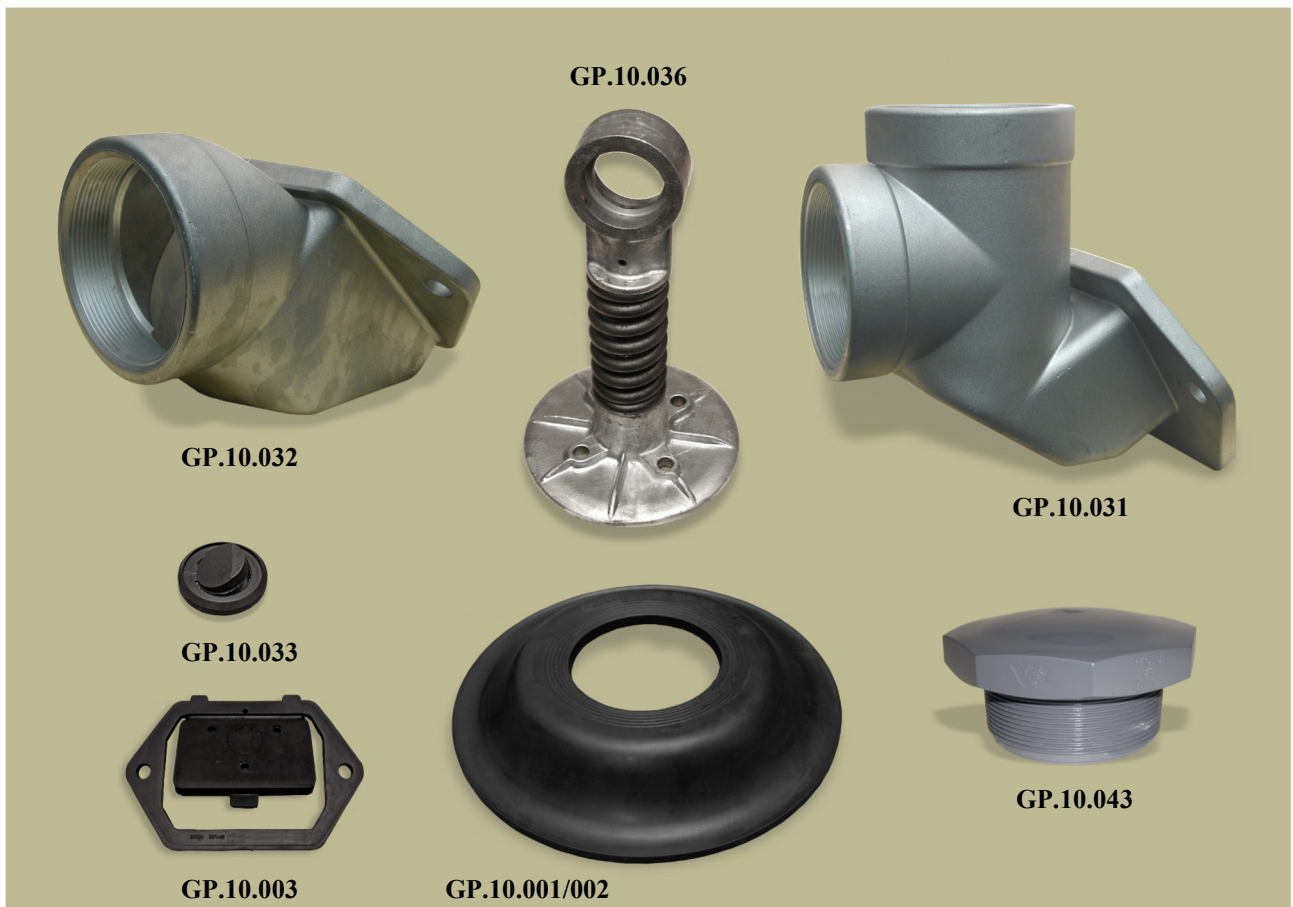

Thigh Deboner Module compatible with Stork Scraperplate



Rodon Int. nr:	Description:	Partnr.OEM:	Pos.nr:
DM.20.004	Scraperplate	4R 593 278	417



Filetting Machine compatible with Meyn Chain for mandrel block



Rodon Int. nr:	Description:	Partnr.OEM:	Pos.nr:
FL.10.502	Chain for mandrel block	0990.FL00.000.09	216



Filleting Machine compatible with Stork

Various parts



Rodon Int. nr:	Description:	Partnr.OEM:	Pos.nr:
FL.20.002	Scraper S.S. L.H.	392.3982-392.982	
FL.20.003	Scraper S.S. R.H.	392.3983-392.983	
FL.20.004	Excenter		
FL.20.005	Scraper S.S. top	394.5860	
FL.20.006	Scraper S.S. bottom	394.58590	
FL.20.007	Slide block	662.600	
FL.20.008	Block	670.637	
FL.20.009	Shaft D=30 L=122	663.875	
FL.20.010	Rod D=12 L=75	655.209	
FL.20.011	Plate S.S.	563.854	
FL.20.012	Pin D=8 L=210 S.S.	666.243	
FL.20.013	Plug Synth.	655.207	
FL.20.014	Pin D=6 L=60 S.S.D=1/4 inch (6,35mm)	660.479	
FL.20.015	O-ring	00.2173.248	



FL.20.005



FL.20.006



FL.20.004



FL.20.002 / FL.20.003

Cut-up Machines compatible with Meyn Bevel gearbox complete and various parts



Rodon Int. nr:	Description:	Partnr.OEM:	Pos.nr:
DM.10.001	Conical gear wheels (TM90 LH + RH)	0990.DM01.004.00 – 990.1620	7
DM.10.002	Conical gear wheels (TM 100 LH)	0990.DM01.007.00 – 990.1622	7
DM.10.003	Conical gear wheels (TM 100 RH)	0990.DM01.006.00 – 990.1621	7
DM.10.004	Shaft bevel gearbox (LH thread)	0990.DM00.020.00 – 990.0254	3
DM.10.005	Shaft bevel gearbox (RH thread)	0990.DM00.022.00 – 990.0253	3
DM.10.009	Bearing housing bevel gearbox	0990.DM01.002.00 – 990.3013	2
DM.10.010	Gearbox housing for TM90 + TM100	0990.DM01.001.00 – 990.3014	1
DM.10.502	Bevel gearbox RH for TM 90	0990.DM00.000.03	1-22, not 9, 10, 21
DM.10.503	Bevel gearbox LH for TM 90	0990.DM00.000.04	1-22, not 9, 10, 21
DM.10.504	Bevel gearbox RH for TM 100	0990.DM00.000.37	1-22, not 9, 10, 21
DM.10.505	Bevel gearbox LH for TM 100	0990.DM00.000.38	1-22, not 9, 10, 21



DM.10.001



DM.10.002

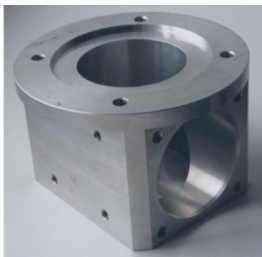

DM.10.010



DM.10.004



DM.10.005



DM.10.504



DM.10.009



DM.10.502

Cut-up Machines compatible with Meyn Knife Holder and Gaskets



Rodon Int. nr:	Description:	Partnr.OEM:	Pos.nr:
DM.10.006	Clamping nut with LH thread	0990.DM00.020.00 – 990.3018	5/21
DM.10.007	Clamping nut with RH thread	0990.DM00.022.00 – 990.3019	5/21
DM.10.008	Knife holder bevel gearbox	0990.DM00.024.00 – 990.3017	4
DM.10.024	Gasket bevel gearbox	0990.IDP1.019.00 – 990.3020	6
DM.10.025	Gasket bevel gearbox	0990.IDP1.020.00 – 990.3021	8

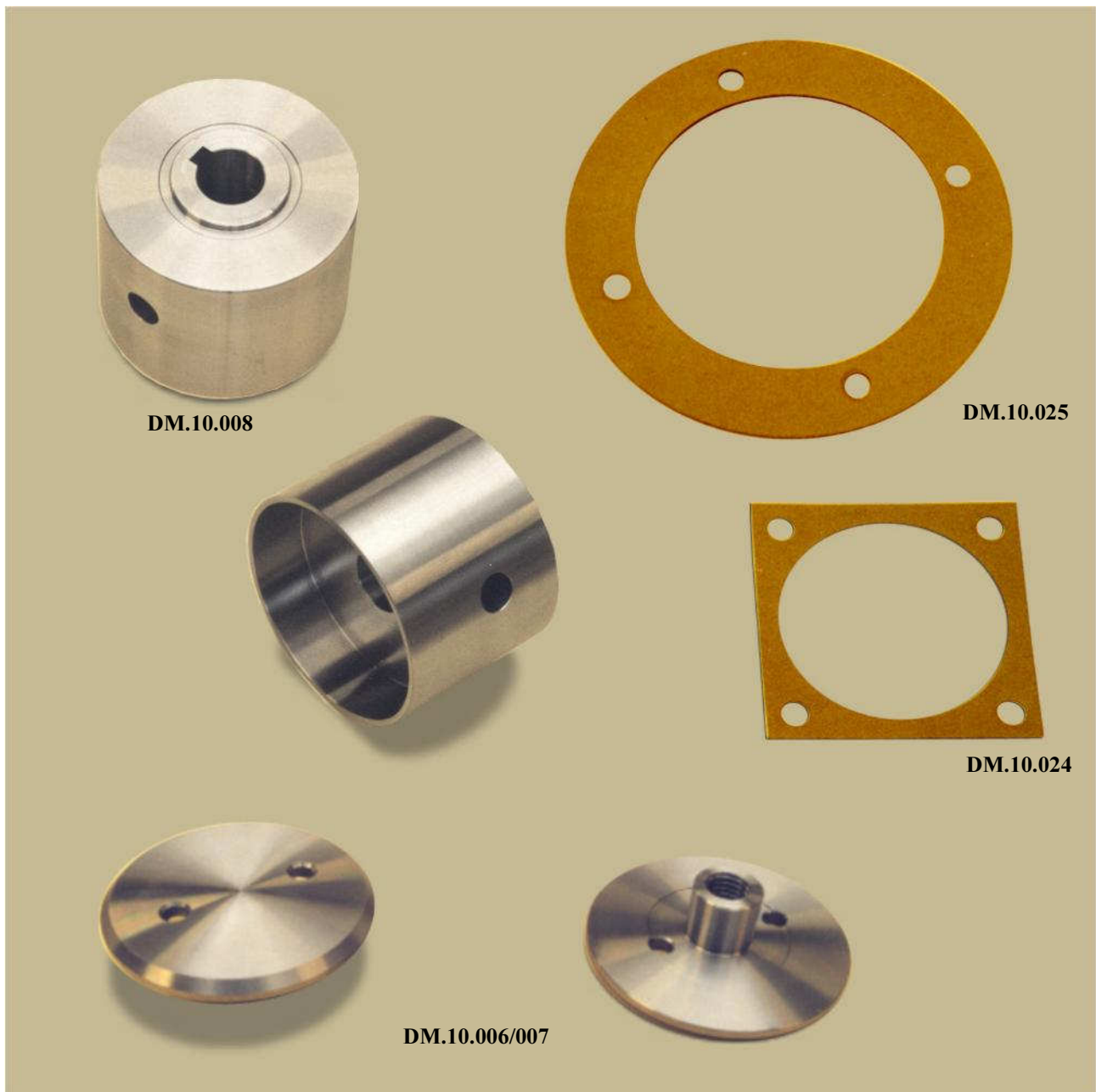

Cut-up machine compatible with Systemate

Various parts



Rodon Int. nr:	Description:	Partnr.OEM:	Pos.nr:
DM.30.001	Ring for height adjustment unit	IC07.000.003	
DM.30.002	Spindle	IC07.000.00LB	
DM.30.003	Gearbox	IC07.000.000	
DM.30.004	Disc 190-100/30.2x48 4xSL15	72.20.006.000	
DM.30.005	Bladeshaft LH	08.06.000.012	
DM.30.006	Disc Bladeshaft LH	08.06.003.001	
DM.30.501	Height adjustment unit		

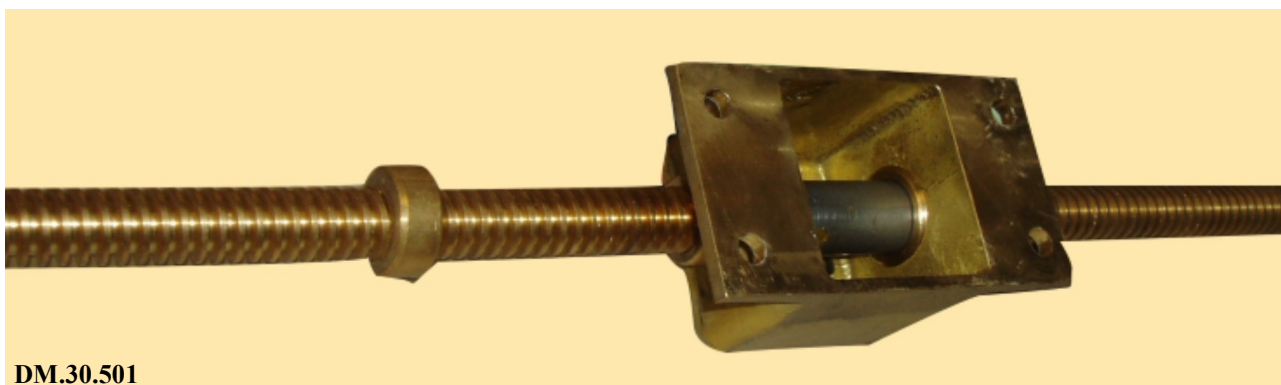
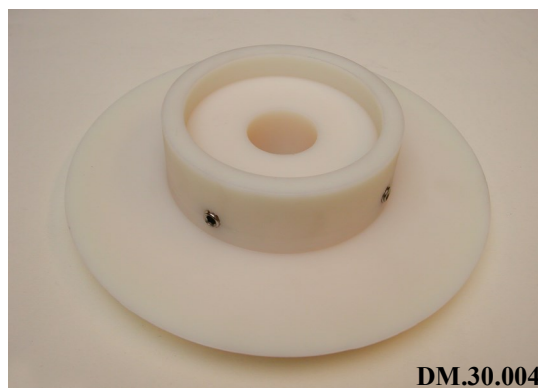

Thigh Deboner compatible with Meyn Diaphragm



Rodon Int. nr:	Description:	Partnr.OEM:	Pos.nr:
TD.10.001	Diaphragm 10mm 55° Shore	89.3561.160.0013	107
TD.10.002	Diaphragm 11mm 55 shore	89.3561.160.0014	107
TD.10.003	Diaphragm 12mm 55° Shore	89.3561.160.0015	107
TD.10.008	Diaphragm 14mm 55° Shore	89.3561.160.0026	107
TD.10.009	Diaphragm 15mm 55 shore	89.3561.160.0023	107
TD.10.004	Diaphragm 10mm 61° Shore	89.3561.160.0010	107
TD.10.005	Diaphragm 11mm 61° Shore	89.3561.160.0011	107
TD.10.006	Diaphragm 12mm 61° Shore	89.3561.160.0012	107
TD.10.011	Diaphragm 12mm 75 shore		107
TD.10.010	Diaphragm 13mm 75 shore		107
TD.10.012	Diaphragm 17mm		107



Crusher compatible with Stork Reductor



Rodon Int. nr:	Description:	Partnr.OEM:	Pos.nr:
PKN.20.001	Reductor	4R.309.294	23
PKN.20.002	Reductor	4R.442.004	

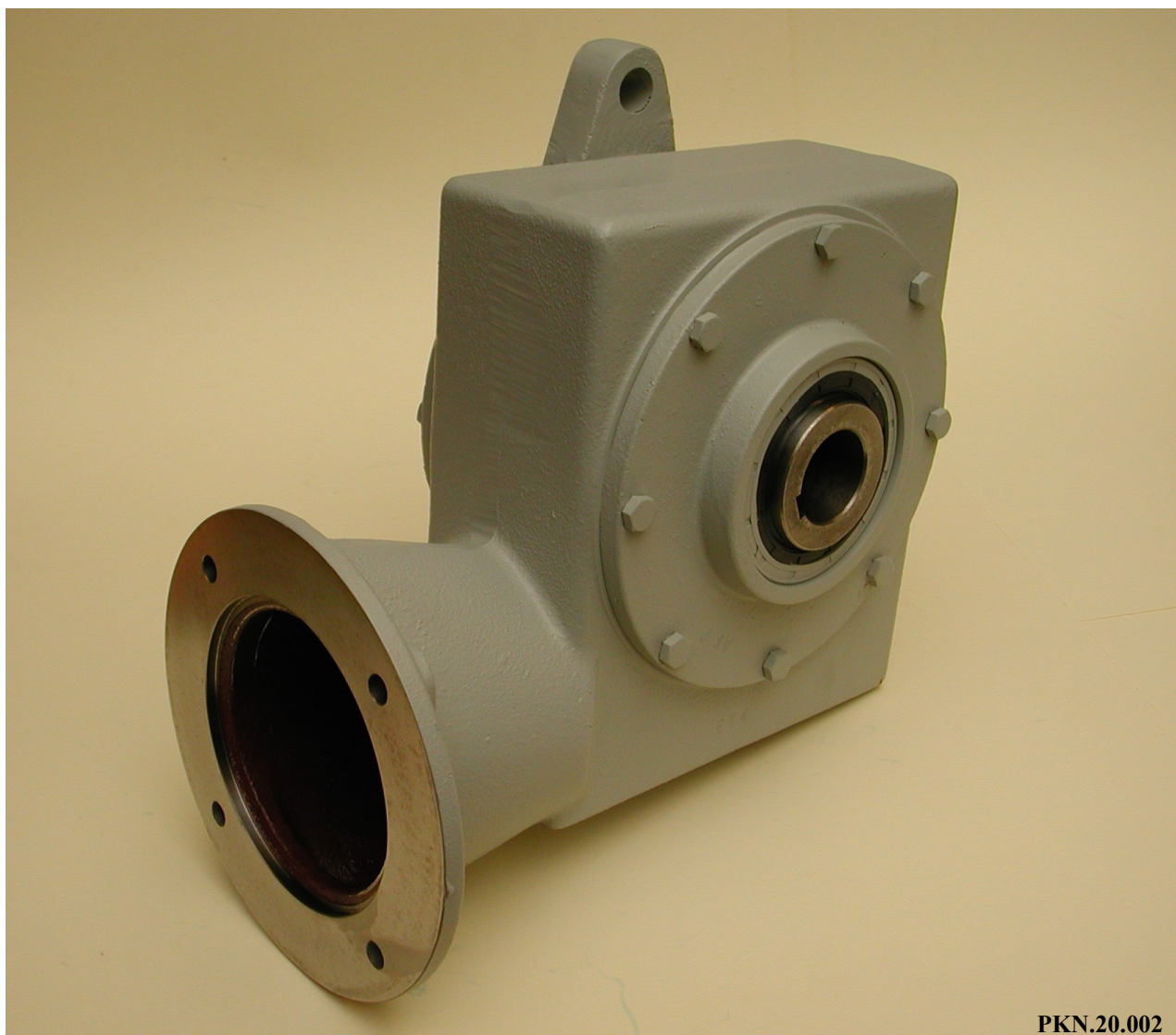

Titan compatible with Stork Various machines



Rodon Int. nr:	Description:	Partnr.OEM:	Pos.nr:
1200.CD70B.001	Hydraulic cylinder CD70B 25/16/060Z11/13 HFDM 11T	090.252.231	
1200.CD70K.001	Hydraulic cylinder CD70K 40/25/100Z11/13 HFDM11T		
1200.CD70K.002	Hydraulic cylinder CD70K 25/16/045Z11/13 HFDM 11T	090.252.223	
1200.CDT3.001	Hydraulic cylinder CDT3ME5/40/28/250 Z1X B1HDDT BY LY=20mm	475.7461	
1200.CY70H.001	Hydraulic cylinder CY70H 32/18/250Z11/13 LXDM 11T Z19336	090.252.230	
1100.0400.3701	Motorvariator	V. 262.328	

